

JANAM

XM5 Android User Manual



Technology at Work®.



XM5 User Manual

CONTENTS

1. INTRODUCTION	6
<i>Trademarks</i>	6
<i>About the XM5 Mobile computer</i>	6
<i>Accessories</i>	7
2. SAFETY REGULATIONS	8
2.1. General Safety Rules	8
2.2. Power Supply	8
2.3. Laser Safety	9
2.4. LED Safety	11
2.5. FCC/ EU RF Exposure	11
2.6. CB Scheme	11
2.7. FCC Part 15 Regulation	11
2.8. Radio Compliance	12
2.9. WWAN	12
2.10. WEEE Compliance	13
2.11. HAZARDOUS Locations (USA&Canada)	13
2.12. Canadian Compliance	14
3. GETTING STARTED	15
3.1. Install the Battery	15
3.2. Charge the Batteries	17
3.3. LED Indicators	18
3.4. Guidelines for Battery Pack Use and Disposal	18
3.5. Boot the Terminal and Access the Home Screen	19
3.6. The Home Screen	20
3.7. Turning Power On/Off	26
3.8. Using the Stylus	27
3.9. Using File Explorer	27
4. GET TO KNOW YOUR DEVICE	28
4.1. Features of Your Device	28
4.2. XM5 Mobile computer	28
4.3. Front Panel Layout	29
4.4. Display	31
4.5. Using Screen Protectors	31
4.6. Installing Your Screen Protector	31
4.7. Back Panel Layout	34
4.8. Left Side Panel Layout	35

4.9.	<i>Installing Memory Cards</i>	36
4.10.	<i>Right Side Panel Layout</i>	36
4.11.	<i>Top Panel Layout</i>	37
4.12.	<i>Bottom Panel Layout</i>	37
4.13.	<i>Peripherals and Accessories</i>	38
4.14.	<i>MicroUSB Cable</i>	39
4.15.	<i>Li-ion Battery Packs</i>	39
4.16.	<i>Battery Power</i>	39
4.17.	<i>Main Battery Pack</i>	39
4.18.	<i>Managing Main Battery Power</i>	40
4.19.	<i>Resetting the Terminal</i>	41
4.20.	<i>Suspend Mode</i>	41
4.21.	<i>Memory Allocation</i>	42
4.22.	<i>Care and Cleaning of the Products</i>	42
4.23.	<i>XM5 Technical Specifications</i>	42
5.	USING THE KEYPAD	44
5.1.	<i>Numeric Keypad Layout</i>	44
5.2.	<i>Navigation Keys</i>	44
5.3.	<i>Basic Keys</i>	44
5.4.	<i>Alpha/Numeric Modes</i>	45
5.5.	<i>BLUE Key Combinations (Numeric Keypad)</i>	45
5.6.	<i>Program Buttons</i>	46
6.	USING THE IMAGER/SCAN ENGINE	47
6.1.	<i>Overview</i>	47
6.2.	<i>Depth of Field</i>	48
6.3.	<i>Supported Bar Code Symbolologies</i>	49
6.4.	<i>Activating the Imager/Scanner</i>	50
6.5.	<i>Using Demos</i>	50
6.6.	<i>Decoding</i>	50
6.7.	<i>To Decode a Bar Code</i>	50
6.8.	<i>Sample bar Codes</i>	51
6.9.	<i>Omni-Directional Scanning Positions</i>	51
6.10.	<i>Capturing Images</i>	51
7.	USING THE LASER SCANNER	52
7.1.	<i>Overview</i>	52
7.2.	<i>Depth of Field</i>	52
7.3.	<i>Supported Bar Code Symbolologies</i>	53
7.4.	<i>Activating the Laser Scanner</i>	53
7.5.	<i>Using Demos</i>	53
7.6.	<i>Decoding a Bar Code</i>	53
7.7.	<i>Sample Bar Code</i>	54
7.8.	<i>Scanning Positions</i>	54

- 8. USING SCANWEDGE..... 55**
 - 8.1. Overview.....55
 - 8.2. ScanWedge Enable/Disable55

- 9. USING CONTROL PANEL 56**
 - 9.1. Settings56
 - 9.2. Wireless & Network Settings56
 - 9.3. Ethernet Cradle Settings57
 - 9.4. Device Settings59
 - 9.5. Sound Setting59
 - 9.6. Display Settings59
 - 9.7. Storage Settings.....60
 - 9.8. Battery Settings.....60
 - 9.9. Apps Settings.....61
 - 9.10. Barcode Scanner Settings Settings63
 - 9.11. Personal Settings65
 - 9.12. Location access Settings.....65
 - 9.13. Security Settings66
 - 9.14. Language & input Settings.....68
 - 9.15. Factory data Reset.....69
 - 9.16. Account Settings70
 - 9.17. System Settings71
 - 9.18. Date & Time Settings.....71
 - 9.19. Accessibility Settings.....71
 - 9.20. Developer options.....72
 - 9.21. About Phone.....72

- 10. COMMUNICATION 73**
 - 10.1. Communication Options73
 - 10.2. Connect to a Windows computer via USB.....73
 - 10.3. Wireless Radios74
 - 10.4. Connecting the Terminal to a Wireless Network.....74
 - 10.5. Advanced Wi-Fi Settings and Network Utilities.....76

- 11. BLUETOOTH HANDLER 77**
 - 11.1. Enabling the Bluetooth Radio77
 - 11.2. Connecting to Other Devices77
 - 11.3. Pairing Bluetooth Devices78
 - 11.4. Setting Up a Bluetooth Printer78

- 12. CAMERA 79**
 - 12.1. *Introduction*79
 - 12.2. *Camera Function*79
 - 12.3. *Camera Controls Overview*80
 - 12.4. *Key Camera Adjustments and Options Overview*80
 - 12.5. *Camera Specifications*82

- 13. PHONE 83**
 - 13.1 *Status Icons*83
 - 13.2. *Answer or Divert a Call*84

- 14. TOOLS 85**
 - 14.1. *Properties*85
 - 14.2. *NoNaviBar*86
 - 14.3. *NoSIP*86

- 15. USING THE XM5 DEMOS 87**
 - 15.1. *Introduction*87
 - 15.2 *GPS Demo--Overview*87
 - 15.3 *Image Demo--Overview*88
 - 15.4. *NFC Demo--Overview*88
 - 15.5. *Ping Demo--Overview*89
 - 15.6 *Print Demo--Overview*90
 - 15.7. *Scan Demo--Overview*90

- 16. SINGLE SLOT CRADLE/SINGLE ETHERNET CRADLE DEVICE 91**
 - 16.1. *Overview*91
 - 16.2 *Battery Charging*91
 - 16.3 *Power Supply*91
 - 16.4. *Front Panel*91
 - 16.5. *Back Panel*92
 - 16.6 *Powering the Device*92
 - 16.7. *Charging the Battery*93
 - 16.8 *Technical Specifications for Cradle*94

- 17. 4-SLOT BATTERY CHARGER 95**
 - 17.1. *Overview*95
 - 17.2. *Power Supply*95
 - 17.3. *Front Panel*95
 - 17.4. *Back Panel*96
 - 17.5. *Charging the Battery*97
 - 17.6. *Technical Specifications*98

1. Introduction

Thank you for purchasing the XM5 mobile computer. This manual provides you with safety information, basic features and operations of the XM5 device. Please review this manual before using your mobile computer and peripherals to ensure safe and proper use.

Trademarks

The official name of Windows XP is Microsoft Windows XP Operating System.

The official name of Windows Vista is Microsoft Windows Vista Operating System.

The official name of Windows 7 is Microsoft Windows 7 Operating System.

The brand names and product names of other Microsoft products are trademarks of Microsoft Corporation in the US and other countries.

Other company and product names given in this manual or displayed in this software may be the trademarks of their respective companies.

About the XM5 Mobile computer

Because it supports Android™ and Microsoft Windows Embedded® Handheld 6.5 on the same device, Janam's super-rugged, super-capable and super-affordable XM5 mobile computer eliminates the stress and cost associated with forced application migration and expensive hardware upgrade. Customers can choose the operating system that meets their business needs today while extending their mobility investment years into the future.

The XM5 redefines productivity and is built to withstand the rigors of heavy-duty use in the field. It combines the latest technological advancements in mobile devices with a sleek and rugged design to provide the power and flexibility that enterprise and government customers demand. Equipped with 4G-ready WWAN and 802.11a/b/g/n Wi-Fi communications, the XM5 ensures mobile workers will be able to access voice and data anytime, anywhere. Additional features include the choice between a 1D/2D imager or 1D laser scanner, as well as integrated RFID and NFC reading capabilities, front and rear facing cameras, Bluetooth and smart battery power management.

The XM5 survives repeated 5' drops to concrete across a wide operating temperature range, is sealed to IP65 standards and is UL-certified to provide ultimate reliability in extreme and hazardous locations.

Accessories

- ❑ **Cradles** (including DC 5V 4A Adaptor)
 - CRD-P1-005U (XM5-Single Slot Cradle)
 - CRD-P1-005E (XM5-Single Ethernet Cradle)

- ❑ **Batteries**
 - 4000mAh Battery Pack, Standard Capacity (60-BTSC)

- ❑ **Power Supply**
 - AC Adaptor, INPUT: AC100~240V 50/60Hz, OUTPUT: DC5V 1.8A with MicroUSB type

- ❑ **Cables**
 - MicroUSB Cable
 - MicroUSB Charge Cable

- ❑ **Others**
 - Stylus Pen and tether
 - Handstrap

The XM5 ships with the following items:

- Mobile computer
- MicroUSB Cable
- 5V/1.8A AC Adaptor with MicroUSB connector
- Battery Pack
- Stylus Pen and tether
- Handstrap
- LCD Screen Protection Film
- Quick Start Guide

 **NOTE:** Keep the original packaging for use when sending products to the Janam Service Center. Damage caused by improper packaging is not covered under the warranty

 **NOTE:** Rechargeable battery packs are not initially charged or discharged. Before you begin to use the device you must charge the battery pack.

2. Safety Regulations

Symbols in this manual

In this manual, some important items are described with the symbols shown below. Be sure to read these items before using this equipment.

 **WARNING** Indicates a potentially hazardous situation which, if not avoided, could result in death serious injury, or serious damage, or fire in the equipment or surrounding objects.

 **CAUTION** Indicates a potentially hazardous situation, which, if not avoided, may result in minor or moderate injury, partial damage to the equipment or surrounding objects, or loss of data.

 **NOTE** Indicates information to which you should pay attention when operating the equipment.

This section outlines the safety precautions associated with using XM5 mobile computer.

 **NOTE:** *XM5 mobile computers meet or exceed the requirements of all applicable standards organizations for safe operation. However, as with any electrical equipment, the best way to ensure safe operation is to read this manual carefully before performing any type of connection to the mobile computer and operate them according to the agency guidelines described in the manual.*

2.1. General Safety Rules

 **CAUTION**

- Use only the components supplied by the manufacturer for the specific XM5 being used.
- Do not attempt to disassemble the XM5 mobile computer, as it does not contain parts that can be repaired by the user. Any tampering will invalidate the warranty.
- When replacing the battery pack or at the end of the operative life of the XM5 mobile computer, disposal must be performed in compliance with the laws in force in your country.
- Before using the devices and the battery packs, read this manual carefully.
- Do not submerge the XM5 mobile computer in liquid products.

2.2. Power Supply

The power supply for this device has met applicable KCC/CCC safety requirements. Please adhere to the following safety instructions per UL guidelines:

- FAILURE TO FOLLOW THE INSTRUCTIONS OUTLINED MAY LEAD TO SERIOUS PERSONAL INJURY AND POSSIBLE PROPERTY DAMAGE.
- IMPORTANT SAFETY INSTRUCTIONS – SAVE THESE INSTRUCTIONS.

 **WARNING**

- DANGER – TO REDUCE THE RISK OF FIRE OR ELECTRIC SHOCK, CAREFULLY FOLLOW THESE INSTRUCTIONS.

Use only Janam-approved power supply. Use of a non-Janam-approved power supply may be dangerous and the warranty does not cover damage to the device caused by non-Janam-approved power supply. The package includes international AC plugs. The AC plugs must be plugged in the power supply before the power supply itself is plugged on the wall outlet. The power supply is intended to be correctly oriented in a vertical or horizontal or floor mount position.

2.3. **Laser Safety**

 **CAUTION**

A Class 2 laser is safe because the blink reflex limits the exposure to no more than 0.25 seconds. It only applies to visible-light lasers (400–700 nm). Class-2 lasers are limited to 1mW continuous wave, or more if the emission time is less than 0.25 seconds or if the light is not spatially coherent. Although staring directly at the laser beam momentarily causes no known biological damage, avoid staring at the beam as one would with any very strong light source, such as the sun.

The laser light is visible to the human eye and is emitted from the laser output window shown on page 10.

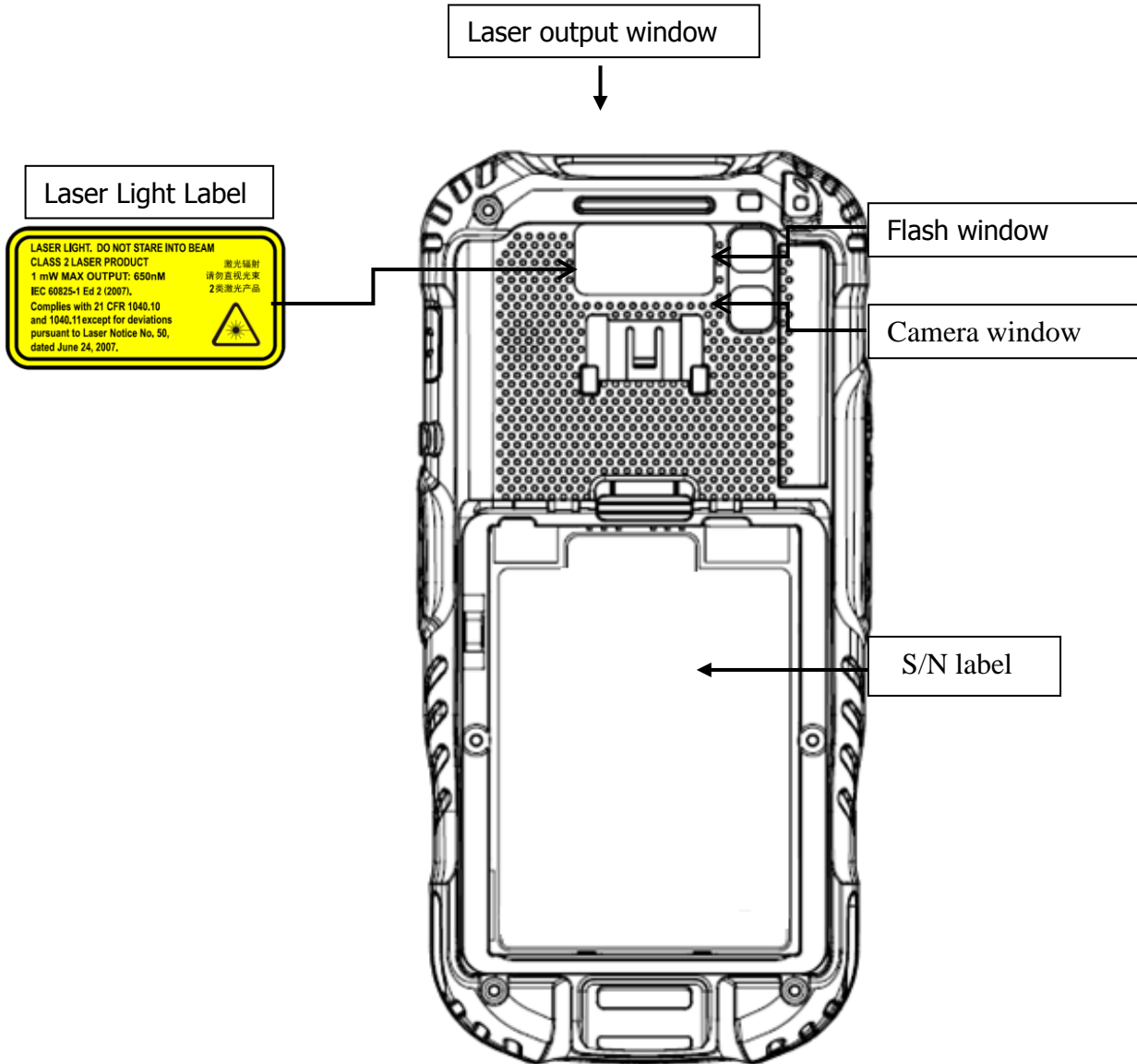

If the above laser light label is attached to your device, it indicates the product contains a laser engine or laser aimer that emits laser light. The following information is provided to comply with the rules imposed by international authorities and refers to the correct use of the XM5 mobile computer.

Laser Safety Statement

This product has been tested in accordance with and complies with CDRH 21 CFR 1040.10 and 1040.11 and IEC 60825-1 Ed 2 (2007) except for deviations pursuant to Laser Notice No 50, dated June 24, 2007. LASER LIGHT. DO NOT STARE INTO BEAM. CLASS 2 LASER PRODUCTS. 1 mW MAX OUTPUT: 650nm. For installation, use and maintenance, it is not necessary to open the device.

 **WARNING:** Opening or servicing any part of the optics cavity by unauthorized personnel may violate laser safety regulations. The optics system is a factory only repair item.



WARNING: Use of controls or adjustments or performance of procedures other than those specified herein may result in exposure to hazardous visible laser light.

2.4. LED Safety

The LED output on this device has met IEC62471 LED safety and certified to be under the limits of a CLASS 1 LED product.

2.5. FCC/EU RF Exposure

- Body effects

This device complies with FCC/EU RF exposure guidelines set forth for an uncontrolled environment. For body worn operation, this device has been tested and meets the RF exposure guidelines for use with an accessory that contains no metal and positions the handset a minimum of 1.0 cm (0.39 inch) from the body. Use of other enhancements may not ensure compliance with RF exposure guidelines. If you do not use a body-worn accessory and are not holding the device at the ear, position the handset a minimum of 1.0 cm (0.39 inch) from your body when the device is switched on.

Belt-clips, holsters, and similar accessories containing metallic components from others manufacturers should not be used.

Accessories worn close to the body, without keeping a minimum distance of 1 cm (0.39 inch) between the user's body and the device, and that have not been tested for typical body operation, may not comply with FCC's RF exposure limits and should be avoided.

2.6. CB Scheme

This device complies with CB Scheme IEC 60950-1

2.7. FCC Part 15 Regulation

Pursuant to part 15 of the FCC Rules, you are cautioned that changes or modifications not expressly approved by Janam could void your authority to operate the XM5 mobile computer.

This device complies with part 15 of the FCC Rules. Operation is subject to the following two conditions: (1) This device may not cause harmful interference, and (2) this device must accept any interference received, including interference that may cause undesired operation.

This device has been tested and found to comply with the limits for a Class B digital device, pursuant to Part 15 of the FCC Rules. These limits are designed to provide reasonable protection against harmful interference in a residential installation. This equipment generates uses and can radiate radio frequency energy and, if not installed and used in accordance with the instructions, may cause harmful interference to radio communications. However, there is no guarantee that interference will not occur in a particular installation. If this equipment does cause harmful interference to radio or television reception, which can be determined by turning the equipment off and on, the user is encouraged to try to correct the interference by one or more of the following measures:

- Reorient or relocate the receiving antenna.
- Increase the separation between the equipment and receiver.
- Connect the equipment into an outlet on a circuit different from that to which the receiver is connected.
- Consult the dealer or an experienced radio/TV technician for help.

In accordance with FCC 15.21, changes or modifications not expressly approved by the party responsible for compliance could void the user's authority to operate the equipment.

The antenna(s) must not be co-located or operating in conjunction with any other antenna or transmitter. To maintain compliance with FCC/EU RF exposure guidelines for body-worn operation, do not use accessories that contain metallic components.

2.8. Radio Compliance

XM5 RF terminals are in conformity with all essential requirements of the R&TTE Directive (1999/5/EC).

This device is marked with  in accordance with the Class II product requirements specified in the R&TTE Directive, 1999/5/EC. The device is intended for use throughout the European Community; PAN European Frequency Range: 2.402 ~ 2.480 GHz.

Restrictions for use in France are as follows:

- Indoor use: maximum power (EIRP*) of 100 mW for the entire 2.400 ~ 2.4835 GHz
- Outdoor use: Maximum power (EIRP*) of 100 mW for the 2.400 ~ 2.454 GHz band and maximum power (EIRP*) of 10 mW for the 2.454 ~ 2.483 GHz band.

 The CE mark on the device indicates that the system has been tested to and confirms with the provisions noted within the 2004/108/EC Electromagnetic Compatibility Directive and the 2006/95/EC Low Voltage Directive, 1999/5/EC (R&TTE), and 2011/65/EU (RoHS). Janam shall not be responsible for use of our product with equipment (i.e., power supplies, personal computers, etc.) that is not CE marked and does not comply with the Low Voltage Directive.

2.9. WWAN

In radio systems configured with mobile computers and access points, the frequencies to be used must be allowed by the spectrum authorities of the specific country in which the installation takes place. Be absolutely sure that the system frequencies are correctly set to be compliant with the spectrum requirements of the country. The Radio modules used in this product automatically adapt to the frequencies set by the system and do not require any parameter settings. The TYPE field shows the correspondence between XM5 types and radio modules:

HSPA

HSPA, or Evolved High-Speed Packet Access, is a technical standard for wireless, broadband telecommunication. HSPA enhances the widely used WCDMA (UMTS) based 3G networks with higher speeds for the end user.

2.10. WEEE Compliance

Information for the user in accordance with the European Commission Directive 2012/19/EU of the European Parliament and of the Council of 4 July 2012 on Waste Electrical and Electronic Equipment (WEEE)

This product has required the extraction and use of natural resources for its production. It may contain hazardous substances that could impact health and the environment, if not properly disposed. In order to avoid the dissemination of those substances in our environment and diminish the pressure on the natural resources, we encourage you to reuse, recycle and recover the product. If the product is disposed according to the Directive, it will avoid potentially negative consequences to the environment and human health which otherwise could be caused by incorrect disposal.



The product marked with crossed out wheeled bin must be disposed separately from municipal waste.

For more detailed information about disposal, reuse, and recycle system, contact your local or regional waste administration.

2.11. Hazardous Locations (USA&Canada)

XM5 terminals are in conformity with all essential requirements of the HAZARDOUS Locations.

According to definitions in the *Canadian Electrical Code, U.S. National Electrical Code, IEC 60079-10* and *CENELEC EN 60079-10*, hazardous locations are defined when fire or explosion may result from the presence of:

- Flammable gases, vapors or liquids (known as Class I)
- Combustible dusts (Class II)
- Ignitable fibers or flyings (Class III)

North American Hazardous Location Approval

The following information applies when operating this equipment in hazardous locations:

The XM5 marked "Class I, Division 2, Groups A, B, C and D" are suitable for use in Class I Division 2 Groups A, B, C, D, hazardous Locations and nonhazardous locations only. The XM5 is supplied with markings on the rating nameplate indicating the hazardous location temperature code. When combining products within a system, the most adverse temperature code (lowest "T" number) may be used to help determine the overall temperature

code of the system. Combinations of equipment in your system are subject to investigation by the local authority having jurisdiction at the time of installation.

2.12. **Canadian Compliance**

This radio transmitter has been approved by Industry Canada to operate with the antenna types listed below with the maximum permissible gain and required antenna impedance for each antenna type indicated. Antenna types not included in this list, having a gain greater than the maximum gain indicated for that type, are strictly prohibited for use with this device.

Under Industry Canada regulations, this radio transmitter may only operate using an antenna of a type and maximum (or lesser) gain approved for the transmitter by Industry Canada. To reduce potential radio interference to other users, the antenna type and its gain should be so chosen that the equivalent isotropically radiated power (e.i.r.p) is not more than that necessary for successful communication.

This device complies with Industry Canada license-exempt RSS standard(s).

Operation is subject to the following two conditions:

(1) this device may not cause interference, and (2) this device must accept any interference, including interference that may cause undesired operation of the device.

3. Getting Started

3.1. Install the Battery

The XM5 is shipped with the battery packaged separate from the unit. Follow the steps below to install the battery.

1. Remove the battery compartment door by moving the battery door's lock to the up position while pulling up on the ribs of the battery door.

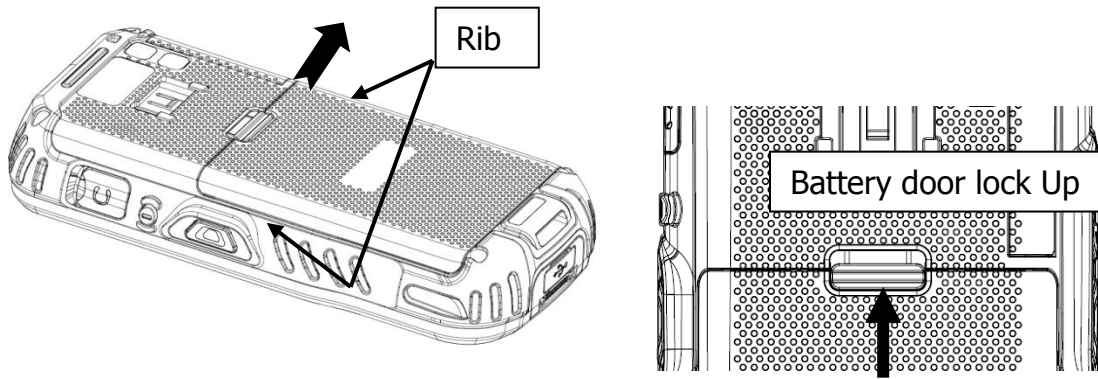

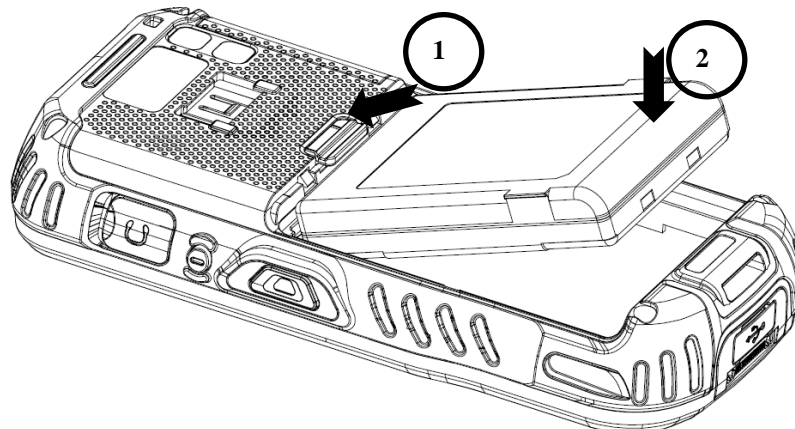

2. Insert the battery with the battery product label facing up and contacts facing the lock.

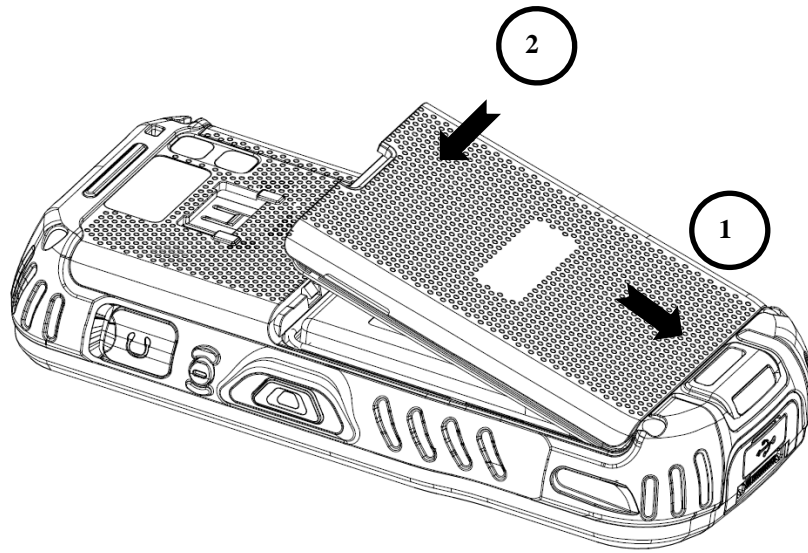

3. To replace the battery door ensure the door tabs (1) face the bottom of the XM5 and the door lock tab (2) faces the locking mechanism.



 **NOTE:** The battery door must be installed prior to booting the unit.

 **WARNING:** Use only Janam-approved Li-Ion battery packs. Unauthorized batteries may result in damage not covered by the warranty.

3.2. Charge the Batteries

The XM5 ships with only the main battery pack significantly charged. Charge the main battery pack with the XM5 micro USB charging cable for **a minimum of 4 or 6 hours before initial use.**

1. Attach the appropriate plug adapter to the plug of the power cable.
2. Insert the plug into the appropriate power source.
Plug the Mobile computer power cable into the USB Jack at the base of the unit.

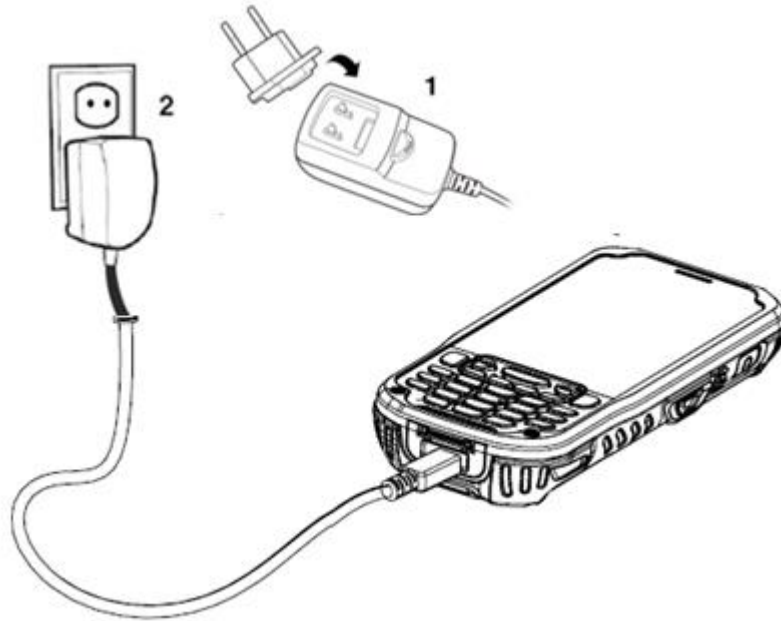

WARNING: Use only Janam-approved peripherals, power cables, and power adapters. Unauthorized peripherals, cables, or power adapters may cause batteries to explode or damage your device. DO NOT attempt to charge damp/wet mobile computers or batteries. All components must be dry before connecting to an external power source.

NOTE: Rechargeable battery packs may not have an initial charge.

NOTE: If you remove the battery pack or it completely discharges, you have a 30-minute window of time to insert a charged battery pack before the backup battery completely discharges.

3.3. LED Indicators

During the charging process the LED positioned at the upper side of the display is red constant. Once the charging process has been completed this LED is green constant.

The battery pack can also be charged by inserting it into the rear slot of the single slot cradle, the single Ethernet cradle or the 4-slot battery charger.

3.4. Guidelines for Battery Pack Use and Disposal

The following are general guidelines for the safe use and disposal of batteries:

- Store the terminal and the spare batteries between 20 to 30 °C (68 to 86 °F) in order to maintain optimal battery performance.

- Standard batteries must be charged at a temperature ranging from 0 to 45°C (±3°C)(32 to 113F).
- The battery level may not be displayed correctly for several minutes after the mobile computer is disconnected from power supply.
- The mobile computer could get warm during charging. This is normal and does not mean a malfunction.
- To achieve the best battery life, turn off the radios when not in use.



WARNING: DO NOT attempt to charge damp/wet mobile computers or batteries. All components must be dry before connecting to an external power source.



WARNING: Never throw a used battery in the trash. It contains heavy metals and should be recycled according to local guidelines.



WARNING: In case of long storage, in order to avoid deep discharge of the battery, it's recommended to partially recharge the battery every two-three months to keep the charge status at a medium level.



WARNING: Installing, charging and/or any other action should be done by authorized personnel and following this manual.

The battery pack may get hot, explode, ignite, and/or cause serious injury if exposed to abusive conditions.

If the battery pack is replaced with an improper type, there is risk of explosion.

Use only a Janam approved power supply. The use of an alternative power supply will void the product warranty, may cause product damage and may cause heat, explode or ignite.

WARNING

Do not short-circuit the battery pack contacts connecting the positive terminal and negative terminal. This might happen, for example, when you carry a spare battery pack in your pocket or purse; accidental short-circuiting can occur when a metallic object such as a coin, clip, or pen causes direct connection of the contacts of the battery pack.

Do not pierce the battery pack or otherwise subject it to strong impacts or shocks.

Do not disassemble or modify (i.e. bend, crush or deform) the battery pack. The battery pack contains safety and protection devices, which, if damaged, may cause the battery pack to generate heat, explode or ignite.

In case of leakage of liquid from the battery, avoid contact with liquid the skin or eyes. If the contact occurs, immediately wash the affected area with water and consult a doctor.

Do not expose the battery pack to liquids.

Do not replace the battery pack when the device is turned on.

Do not remove or damage the battery pack's label.

Do not use the battery pack if it is damaged in any way.

Battery pack usage by children should be supervised.

Collect and recycle waste batteries separately from the device in compliance with European Directive 2006/66/EC, 2011/65/EU, 2012/19/EU and subsequent modifications, US and China regulatory and others laws and regulations about the environment.



NOTE: In order to guarantee an adequate operating autonomy, when replacing the battery pack, the mobile computer checks the battery energy level. If the battery is not sufficiently charged, the mobile computer will not turn on.

In this case, either substitute the battery pack with a charged one (sufficiently charged) or insert the mobile computer into a powered cradle or plug it into the USB charger.

3.5. Boot the Terminal and Access the Home Screen

The terminal begins the boot process as soon as power is applied. Do not press any buttons or attempt to remove the battery during the initial boot process.

3.5.1. Make yourself at home

The first time you power up the XM5 terminal, a [Make yourself at home] screen appears after the boot process is finished.

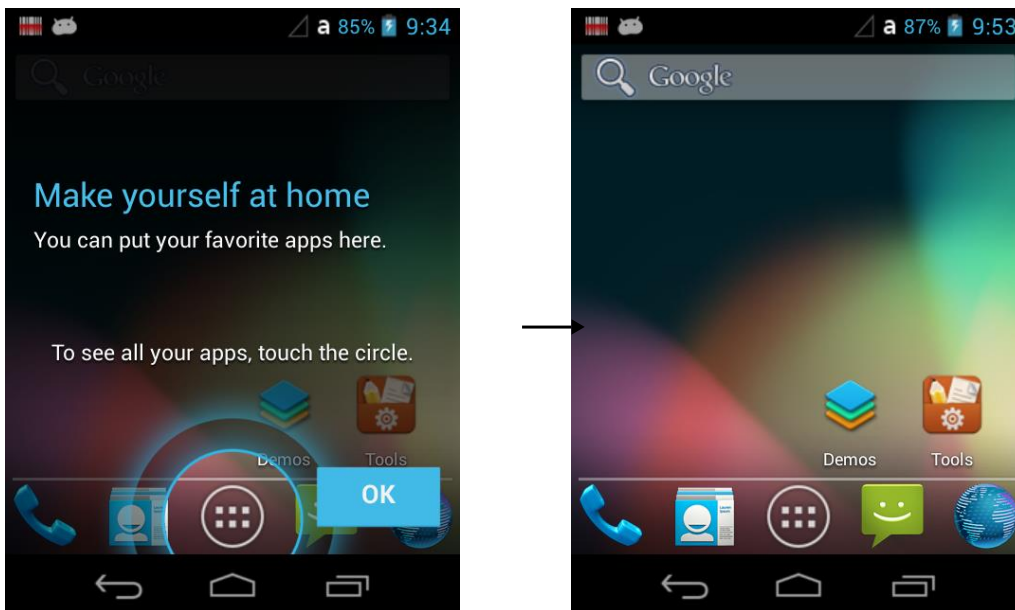

After the initial OK button is touched, the Home Screen appears.

Note: Once you complete the initial [Make yourself at home] Screen, the [Make yourself at home] screen no longer appears when you reboot the device. The Locked screen displays after the terminal completes the boot process

3.5.2. The Locked Screen

Drag the  to the any direction and access the **Home** screen.

NOTE: During the initial charging stage, the terminal may have entered **Suspend Mode** to conserve battery power. In **Suspend mode** the touch screen dims then darkens automatically after a period of no activity.

Press the **Power**  button to wake the terminal.

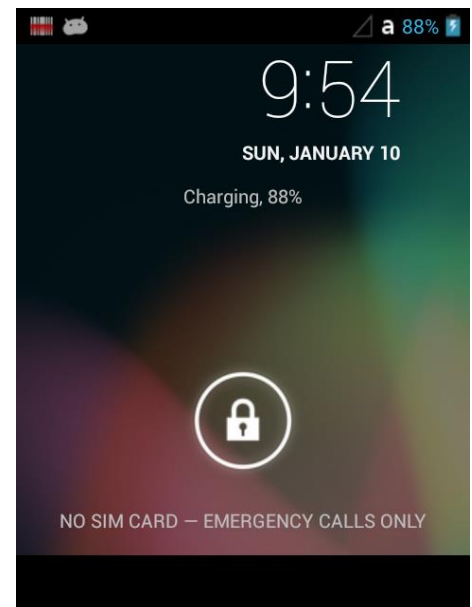

3.6. The Home Screen

The Android™ operating system provides space for user customization and control with five **Home Screen** panels.

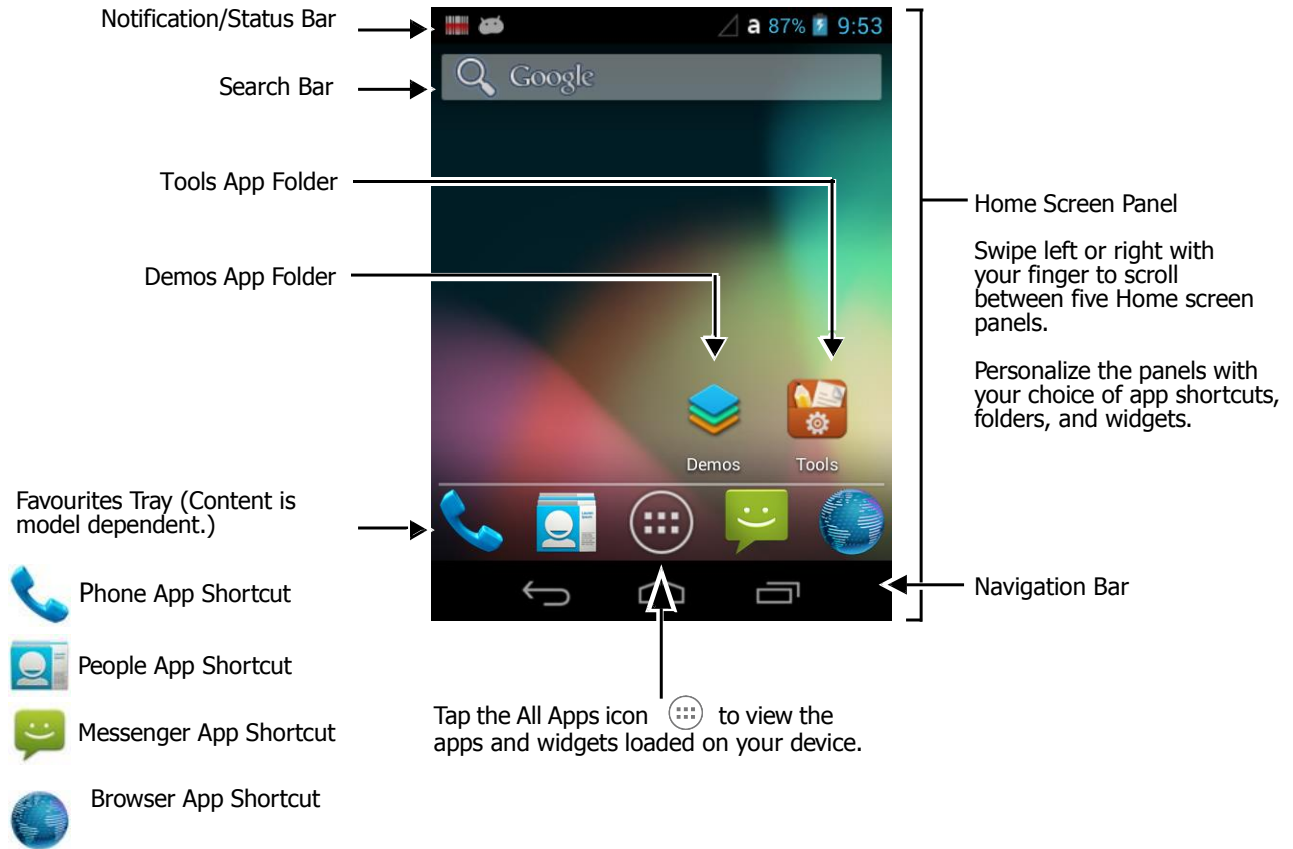

NOTE: You can return to the Home screen at any time, in any application by pressing the  button.

3.6.1. Status Bar

The status bar located at the top of the touch screen displays notifications (on the left), the status of various system functions (on the right), and the current time (on the far right).

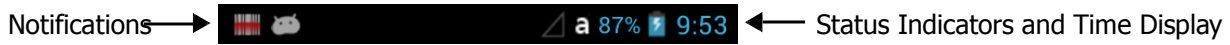





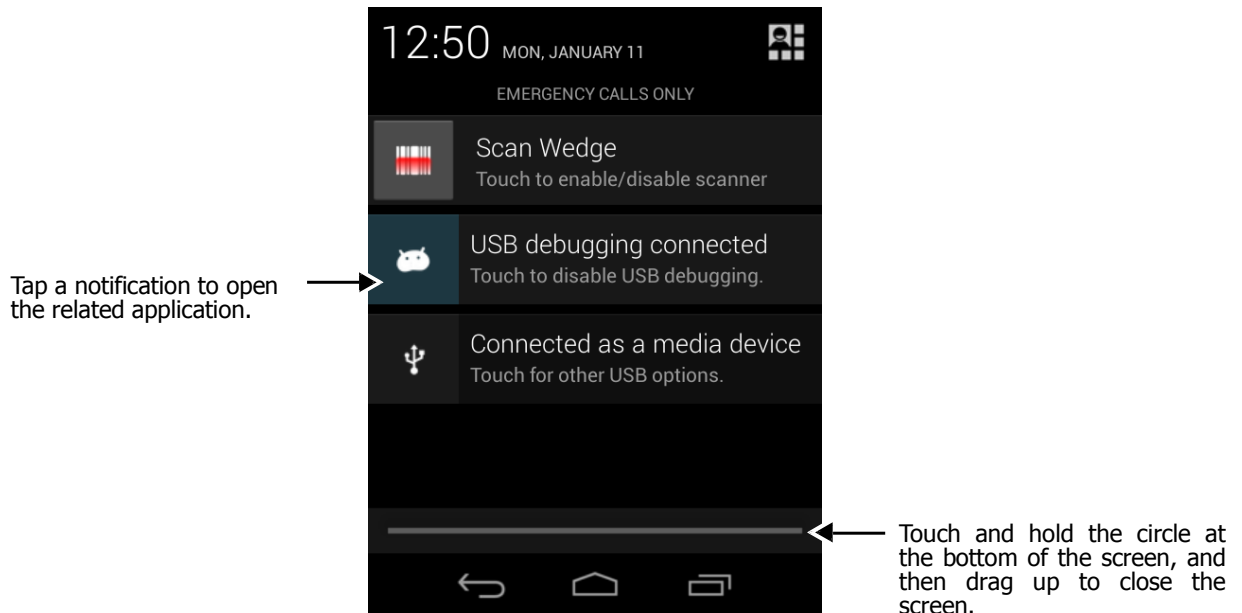





































3.6.2. Notification Panel

A plus sign icon **+** appears on the status bar when the quantity of notifications exceed the available space on the bar. To view all the notifications, touch and hold the status bar, and then drag down to open the notification panel.



Common Status and Notification Icons

Icon	Meaning		
<i>Note: Status and notification icons are hardware and software dependent. Some of the icons listed below may not be relevant for your XM5 model.</i>			
	Open notification panel to see additional notifications		Sound is turned off
	Pending calendar event		Vibrate mode is turned on
	Pending alarm and Alarm is set		Battery charge is at 100%.
	New Hangouts™ message		Terminal is connected to external power and the battery is charging.
	New Gmail™ message		SD card or USB storage is full
	New text message or multimedia message		Bluetooth technology is turned on
	New E-mail		Terminal connected to a device with Bluetooth technology
	Error with text or multimedia message delivery		Bluetooth incoming file notification
	Terminal is connected to a computer using a USB cable		WWAN (voice & data) network signal strength
	ABD active (USB debugging enabled)		The carrier data use threshold has been reached or exceeded
	Uploading data		Wi-Fi network connected and signal strength

Icon	Meaning		
	Downloading data		Ethernet status - disconnected
	Download finished		Ethernet status - connected
	Synchronizing data		Music player active
	Error with sync or sign-in		Call in progress
	The terminal could not synchronize data with the computer		Call in progress using a headset with Bluetooth technology
	GPS is turned on		Call forwarding turned on
	Receiving location data from GPS		Call on hold
	Scanner is disabled		Missed call
	Scanner is enabled		No SIM card is installed
			New Voicemail message
			Speaker phone is on
			Call is muted





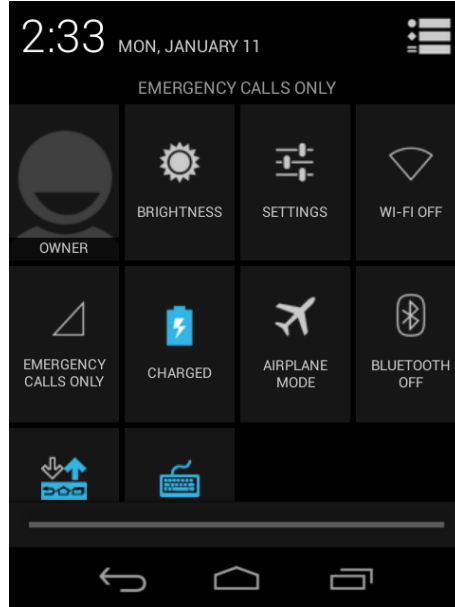



3.6.3. Quick Settings

To view the **Quick Settings**, pull down the notification curtain and touch the  button on the top right of the **Notifications panel**.



NOTE: To view the Notifications panel, touch the  button on the top right of the Quick Settings panel.

Quick Settings List

Icon	When touch		
<i>Note: Status and notification icons are hardware and software dependent. Some of the icons listed below may not be relevant for your XM5 model.</i>			
	Brightness settings is opened.		Settings is opened.
	Wi-Fi Connector is opened.		Mobile network settings is opened.
	Battery settings & information is opened		Airplane mode is enabled/disabled.
	Bluetooth Connector is opened.		Navigation bar is displayed/hidden
	Virtual keyboard is displayed/hidden.		

3.6.4. Search Bar

You can search for an item on the terminal or the Internet using **Google™ Search** at the top of any **Home** screen panel.

Touch inside the box to access the virtual keyboard for text entry. →



To modify the search settings:

1. Touch inside the box then press the  button.
2. Touch **Settings** then select **All, Web, Apps or People**

3.6.5 Personalize the Home Screen Panels and Favorites Tray

Streamline your workflow by customizing the **Home** screen panels and **Favorites** tray with your choice of app shortcuts, folders, and widgets.

To add an app shortcut:

1. Touch **All Apps** .
2. Select and hold the app icon you want to add. The terminal vibrates, and then switches to the home screen.
3. Drag and drop the icon into position on the **Home** screen or in an open spot on the tray.
Hints:
 - To create a folder, drag and drop an app icon on top of another icon.
 - To move a shortcut from the Favorites tray to the Home screen panel, touch and hold the item and then drag and drop the icon onto the Home screen.

To add a widget:

1. Touch **All Apps** .
2. Select the **Widget** tab.
3. Touch and hold the widget you want to add. The terminal vibrates and switches to the Home screen.
4. Drag and drop the widget into the desired position.

To remove/delete an item:

1. Touch and hold the item.
2. Drag the item to the top of the screen where the word Remove is displayed.

To move an item:

1. Tap and hold the item.
2. When the unit vibrates, drag and drop the item in the new location.

NOTE: The next panel automatically opens if you drag the item to the edge of the touchscreen.

Apps and Widgets

Touch the **All Apps** icon  located at the bottom of any **Home** screen to see all the apps and widgets loaded on your terminal.

3.7. Turning Power On/Off

To turn the terminal **On**, Press and release the **Power** button . To turn the terminal Off:

1. Press and hold the **Power** button  until the **Phone Options** menu displays.

NOTE: If the **Show System Dialog** setting is turned off (see page 6-2), the **Phone Options** menu does not display when you press and hold the Power button. The terminal automatically reboots when Power button is held for approximately 8 seconds.

2. Touch **Power Off**.

3.7.1. Suspend Mode

Suspend mode differs from **Power off** mode. **Power off** mode is the equivalent to having no battery or external power source connected to the device. The terminal does not receive incoming calls when power is off since the device completely shuts down. In **Suspend** mode, the device enters a low power state to conserve battery power. The radio associated with the phone maintains enough power to wake the terminal for incoming phone calls. **Suspend** mode automatically turns the touch screen off and locks the terminal to save battery power when the terminal is inactive for a programmed period of time.

1. Press and release the **Power** button  to toggle the terminal in or out of **Suspend** mode.

NOTE: If the **Power key** setting has been turned off (disabled), pressing and releasing the key has no effect.

2. Drag the  to the any direction

NOTE: You should always place the terminal in **Suspend** mode before removing the battery.

To adjust the timeout limit, touch **All Apps**  > **Settings**  > **Display** > **Screen timeout**.

3.8. Using the Stylus

The terminal comes with a stylus included in a loop on the lanyard. Use this stylus (or your finger) to select or enter information on the touch screen. The stylus functions as a mouse; generally, a tap is the same as a click.

Tap Tap the touch screen once to open menu items and select options.



Drag Hold the stylus on the screen and drag across the screen to select text and images.



Tap & hold Tap and hold the stylus on an item and a pop-up menu appears. On the pop-up menu, tap the action of the task you want to perform.





WARNING: Use of objects, such as paper clips, pencils, or ink pens on the touch screen can damage the input panel and may cause damage not covered by the warranty.

3.9. Using File Explorer

Use File explorer to navigate through the files on your system. Tap **All Apps**  > **Tools**  > **OI File Manager**

Press the file you want for a second and delete using the Delete button  on the top right. Cut, Copy or Paste and set the application using Menu button  on the top right.

To install the application:

1. Put the Application file (.apk) on a micro SD card or connect the micro USB cable to a PC.
2. Tap All Apps  > Tools  > OI File Manager
3. Touch/tap the Application file (.apk) on the OI File Manager.
4. If you see the Install blocked, press the Setting button and check the checkbox of Unknown sources in "Settings", "Security".
5. Touch/tap the Install button.
6. If the setup succeeds, "App installed" is shown on the screen.

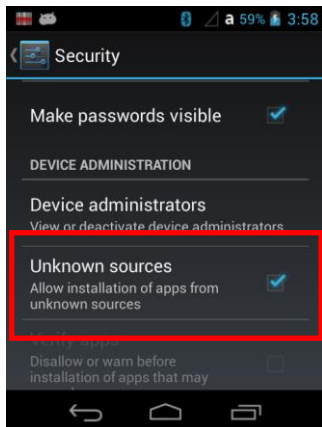
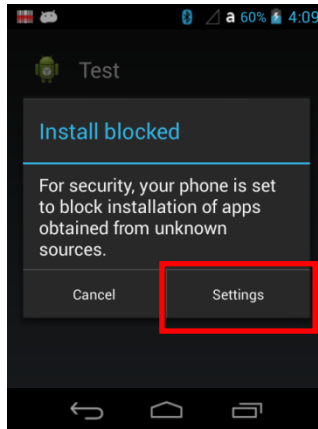
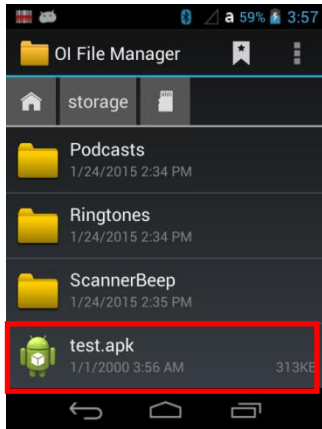

4. Get to Know Your Device

4.1. Features of Your Device

The following list outlines the hardware and a few of the features included in your device.

4.2. XM5 Mobile computer

- Operating Systems: Android 4.2.2(Jelly Bean)
- Micro Processor: Cortex-A8 1GHz
- RAM Memory: 512MB
- FLASH Memory: 1GB
- 3.5" VGA Display: 480x640 Transmissive TFT
- Industrial Grade Touch Screen

- Keyboards: Numeric, Qwerty
- Micro SDHC Expansion Memory Card Interface: Support up to 32 GB
- Power Supply : MicroUSB power adaptor
- Interfaces : Micro-USB connector : USB 2.0 High Speed
- Communications connector: USB 2.0 High speed Client, Host, Charging
- Scan Engine:
 - 1D engine: N4313
 - 2D engine: N560X
- Battery: Li-ion battery, 3.7V/4000mAh/14.8Wh
- IP65 certified enclosures
- Audio: Integral Microphone, Earpiece, Loud Speaker, 3.5pi 4pole Jack for Ear-Mic headset
- BT: Bluetooth Radio 2.1+EDR with Internal Antenna
- WLAN: 802.11 a/b/g/n Radio with Internal Antenna
- Notification LEDs
 - 1) Power indications, 2) Scan reading indications & OS notifications
- Notification Vibration Motor
- Camera : 5M pixel CMOS camera with AutoFocus and LED flash
- Sensors : Proximity sensor and Acceleration sensor
- GSM/GPRS/EDGE : Quad band, 850/900/1800/1900MHz
- UMTS/HSPA: Five band, 800/850/900/1900/2100MHz
- GPS: Assisted GPS
- NFC : 13.56MHz HF, ISO14443A, ISO14443B & ISO15693 are supported

4.3. Front Panel Layout



LED Indicator

- Red** Lights when main battery is charging.
Blinks, when the battery is very low (<10%),
Lights when the battery is low (<20%),
Blinks Red/ Green for battery fault
Lights when a scan fails
Lights when PDA suspends
- Green** Lights, when the PDA resets
Lights when main battery charging has completed.
Blinks as Red / Green indicates battery fault
- Blue** Lights when a scan Pass
Lights when PDA wakes up

Keypad

- 32 numeric keypad (includes side scan, volume and power button).
- 51QWERTY keypad (includes side scan, volume and power button).

Microphone

- Integrated microphone for audio recording and phone calls.



Touch Screen Display

- 3.5 inch TFT VGA (480x640)
- For touch screen input, use the stylus included with the terminal or your finger. While there is a great deal of variation in different applications, you generally achieve greater accuracy with the stylus for buttons or icons that are close together.



WARNING: Use of objects, such as paper clips, pencils, or ink pens on the touch screen can damage the input panel and may cause damage not covered by the warranty.

4.4. Display

Touch **All Apps**  > **Settings**  > **Display** from the screen to set the touch screen **Brightness** level, **Turn keyboard backlight** on or off, **Wallpaper**, turn **Auto-rotate screen** on or off, adjust the touch **Screen timeout** settings, set the on display **Wakeup Source**, set the on screen **Font size**, and enable or disable **Power** button  functions.

4.5. Using Screen Protectors

The XM5 ships with a screen protector and approved stylus. Screen protectors maintain the ongoing integrity (i.e., prevent scratching) of the touch panel.

Use of the stylus **included** with the terminal is recommended at all times.

4.6. Installing Your Screen Protector

When installing a screen protector, use a flat plastic card (e.g., credit card) to apply the screen protector smoothly and remove any air bubbles.

1. Press the Power key to put the terminal in suspend mode.
2. Clean the touch panel thoroughly with a clean, non-abrasive, lint-free cloth. Make sure nothing is on the touch panel.
3. Blue tag with backing film: Peel off this mask before application.

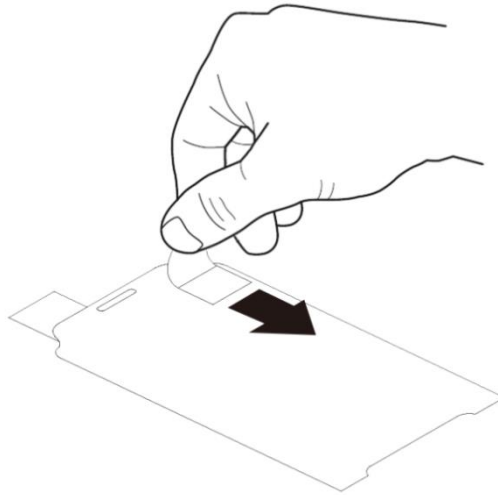

4. Align the exposed edge of the screen protector along the left edge of the touch panel. Make sure that it lies flush with edges of the touch panel.

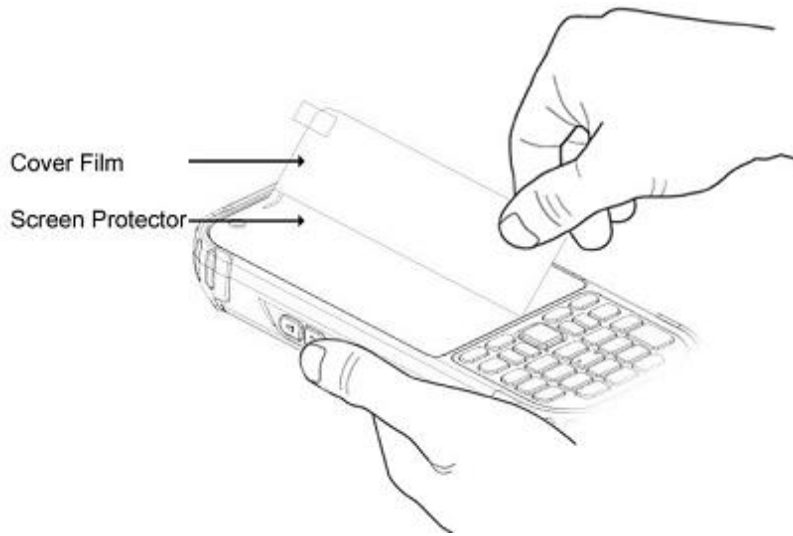

 **NOTE:** To reposition the screen protector, lift up gently and reapply.

5. Yellow tag with cover film:

“Please peel off this mask after application is complete.”

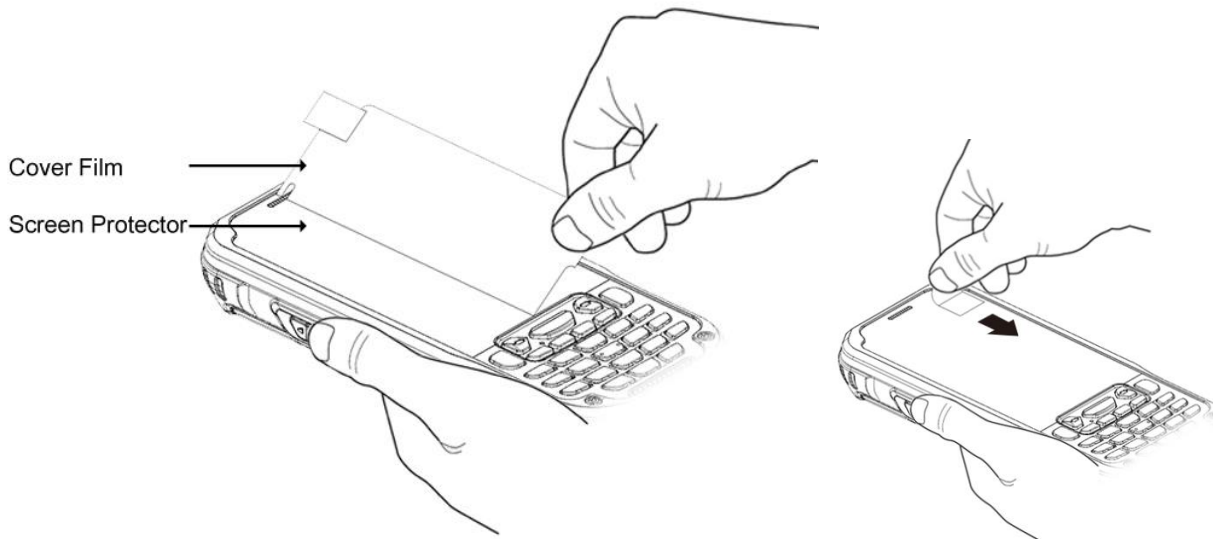

6. Press gently but firmly. Use the card as necessary to smooth out any air pockets or bumps after application

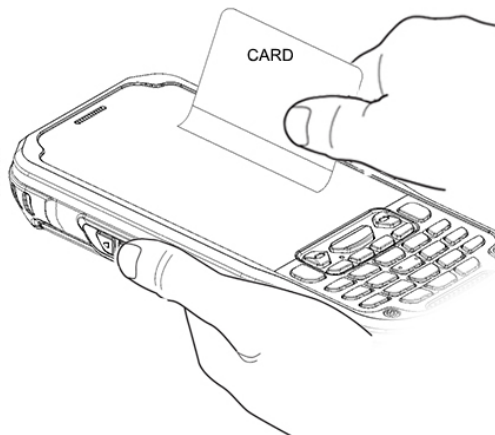

- 7.** Power ON the XM5 and check the touch panel with the stylus.

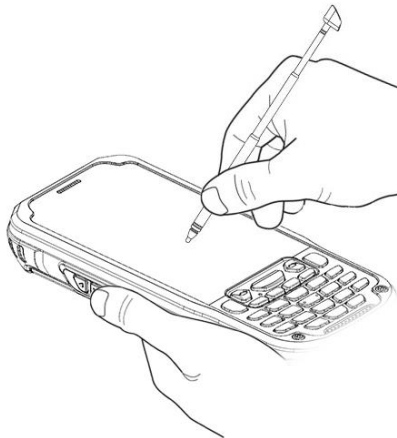

- 8.** Verify that the screen accepts input from the stylus. If not, re-apply the screen protector.
- 9.** Press the Power key to put the terminal back in suspend mode.
- 10.** Clean the surface of the screen protector with a clean, non-abrasive, lint-free cloth.
- 11.** Press the Power key to wake the terminal again.

4.7. Back Panel Layout

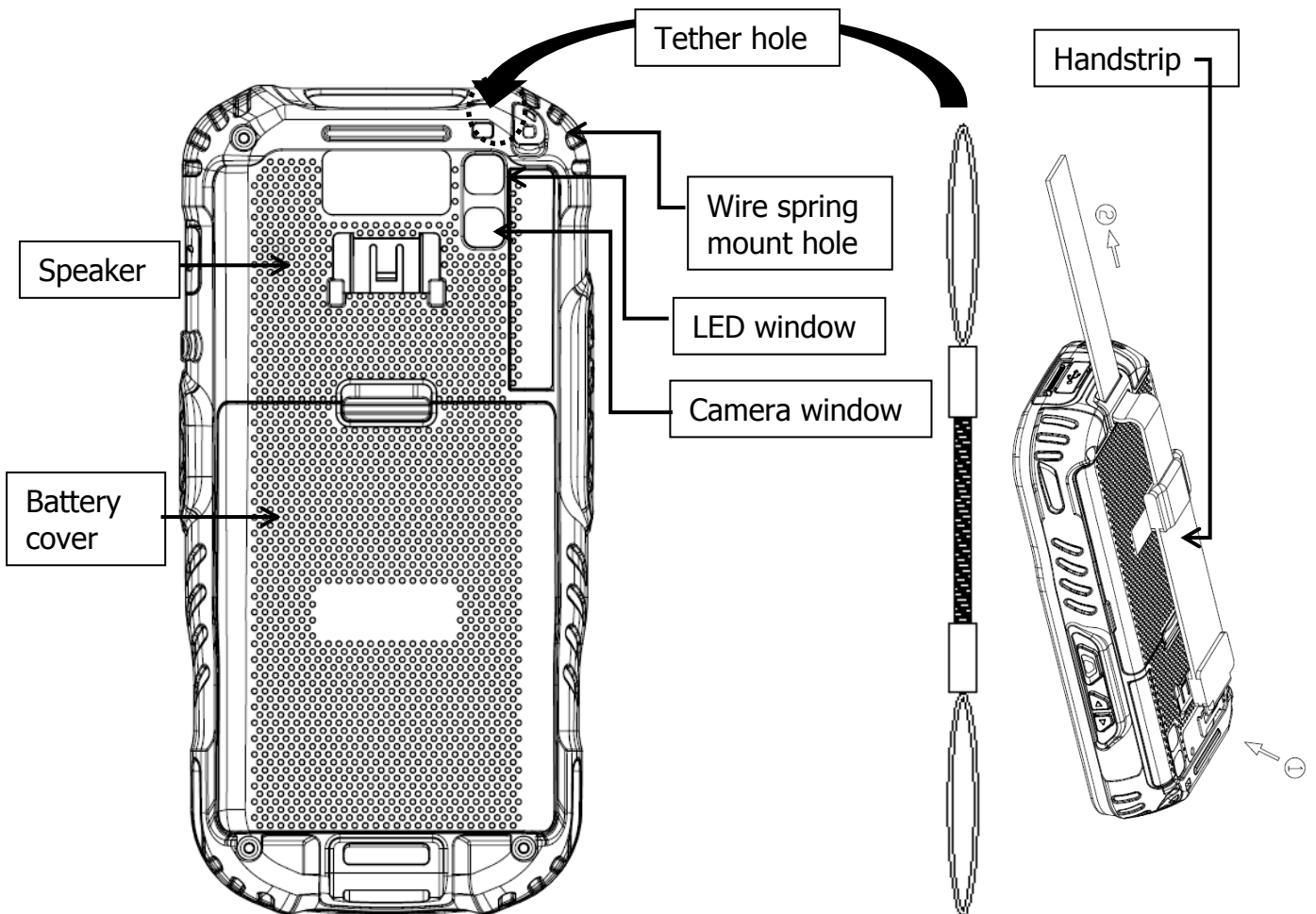

Wrist Lanyard

The XM5 comes with a Wrist Lanyard. See Back Panel Layout drawing for installation.

Hand strap

The XM5 comes with a Hand strap. See Back Panel Layout drawing for installation.

Installed Battery

For information about installing the battery, see Install the Battery (paragraph 3.1).

For information about battery power, see Battery Power (paragraph 4.17).

Speaker

The integrated speaker sounds audio signals for barcode scanning and data entry. The speaker can also be used for playing sounds (e.g., WAV or MP3 files).

The speaker meets the following SPL levels at 10cm:

- 500Hz–80dB
- 1kHz–90dB
- 4kHz–90dB

Stylus and tether

The XM5 is shipped with a stylus inserted in a loop on the tether. Store the stylus in the Lanyard when you're not using it; see Using the Stylus on paragraph 3.8.

4.8. Left Side Panel Layout

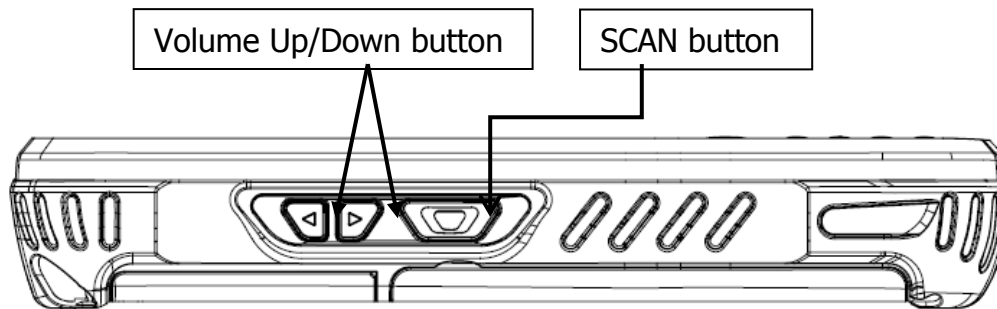

Side Button

Used to control the speaker volume and scanning barcodes.

4.9. Installing Memory Cards

The XM5 supports Micro Secure Digital (SD) memory cards up to 32GB. **Sandisk, Kingstone and ATP micro SD recommended**

To access the Micro SD card slot and insert the card, proceed as follows:

1. Press the **Power** key to put the terminal in Suspend Mode; see Suspend Mode (paragraph 4.23).
2. Remove the battery door on the back of the unit.
3. Remove the battery. There is a label showing the insertion direction of the micro SD card.
4. Insert the SD card with the label facing upward.

 **NOTE:** To remove an installed SD card, tap on the edge lightly to unlock the card; the card will eject, slightly allowing access to the edge for manual removal.

5. To verify that the operating system recognizes the new memory card, open File Explorer and navigate to /storage/sdcard1.

 **WARNING:** Follow proper ESD precautions to avoid damaging the SD. Proper ESD precautions include, but are not limited to, working on an ESD mat and ensuring that the operator is properly grounded. Do not force the card. If you feel resistance, remove the card, check the orientation, and reinsert it. Do not use the Micro SD card slot for any other accessories.

4.10. Right Side Panel Layout

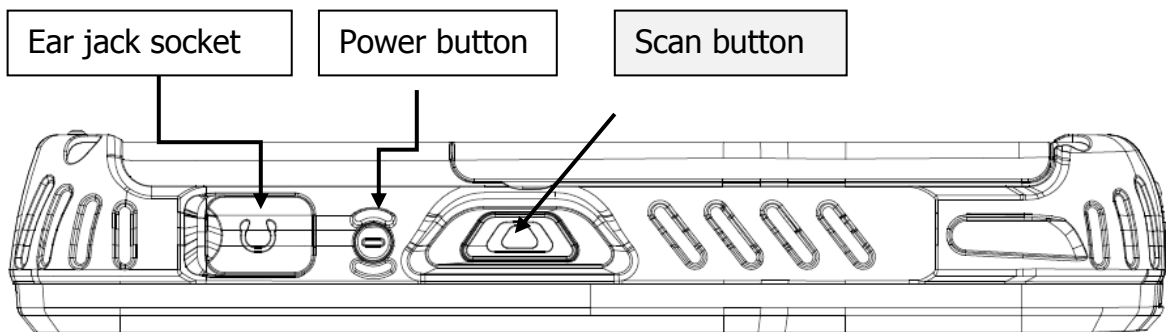

EarJack

3.5pi 4pole Jack. This connector supports Ear-Mic headset

4.11. Top Panel Layout

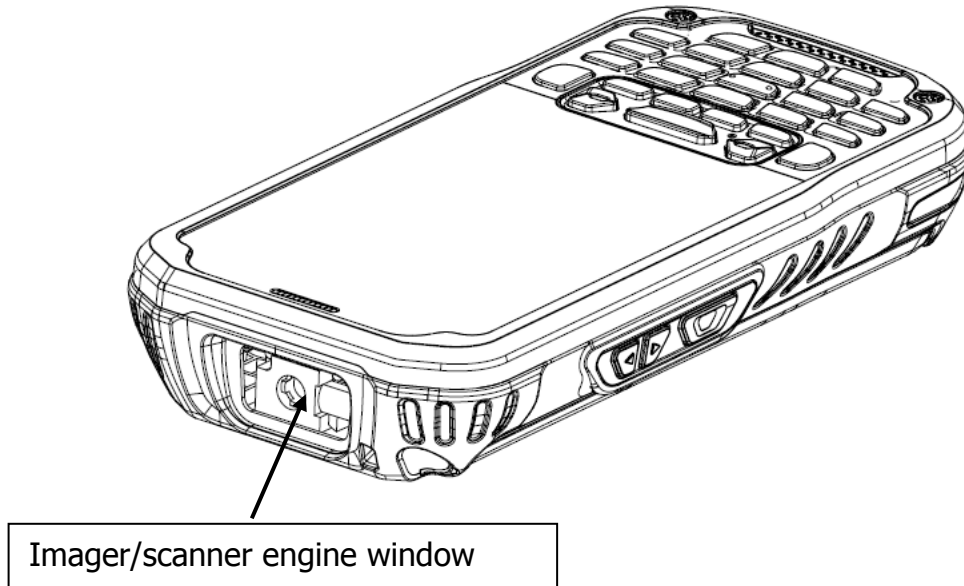

Imager/scanner Engine Window

The angled imager/scanner engine reads and decodes most popular bar code symbologies. For more information, see Using the Imager/scanner Engine (paragraph 6).

4.12. Bottom Panel Layout

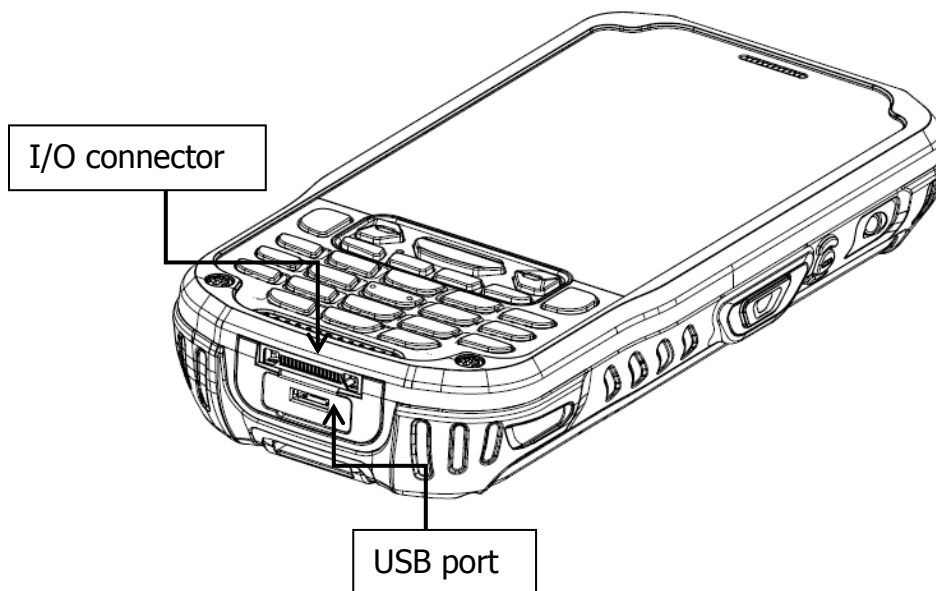

XM5 Connector

The XM5 mechanical connector is designed to work exclusively with MOBILE COMPUTER peripherals and cables. This connector powers the terminal, charges the main battery, and facilitates communication. This connector supports High speed USB 2.0 communication (up to 480 Mbps).

The I/O connector supports the following signals:

	Pin Description	Direction
1	DC IN +5V	PWR
2	DC IN +5V	PWR
3	TXD (RS-232)	OUT
4	RTS (RS-232)	OUT
5	USB Host +5V Enable	OUT
6	USB Host D+	IN/OUT
7	USB Host D-	IN/OUT
8	USB Host Detect#	IN
9	CTS (RS-232)	IN
10	RXD (RS-232)	IN
11	GND	
12	GND	
13	CRADLE Detect#	IN
14	USB Client D+	IN/OUT
15	USB Client D-	IN/OUT
16	USB Client +5V	PWR

 **NOTE:** Signals referenced are for a DTE device.

USB Port

This connector supports High speed USB 2.0 communication (up to 480 Mbps)

4.13. Peripherals and Accessories

The following items are sold separately and enhance your XM5's capabilities.

Single Slot Cradle

This charging and communication cradle supports USB communication, enabling your terminal to interface with the majority of enterprise systems. When a terminal is seated in a powered base, its battery pack charges in five hours for the 4000mAh pack.

For more information, see Single Slot cradle/Single Ethernet cradle Device on paragraph 12.

Single Ethernet Cradle

The Single Ethernet cradle is used to charge the battery and can be used to communicate data from the terminal to a PC/laptop via the Ethernet port.

For more information, see Single Slot cradle/Single Ethernet cradle Device on paragraph 12.

4.14. MicroUSB Cable

The MicroUSB cable is used when communicating between the terminal and a host computer to transfer data via the USB interface.

4.15. Li-ion Battery Pack

The Li-ion battery pack provides the main power supply for the terminal.

4.16. Battery Power

The battery must be charged to full capacity before using the XM5 for the first time!
Charge the main battery pack for **a minimum of 5 hours before initial use.**

4.17. Main Battery Pack

Standard Capacity: Li-ion 3.7V/4000mAh/14.8Wh

The Li-ion battery pack is the primary power source for the Mobile computer as well as for the internal backup battery.

Changing the Main Battery Pack

Before changing a battery pack, press the Power key to put the terminal in Suspend Mode so that operations are suspended before removing the main power source. Always put the terminal in Suspend Mode prior to changing the battery.

 **NOTE:** *The battery door must be installed prior to booting the unit.*

Charging Options

- AC Power Supply to USB Port direct
- Single slot docking cradle/Single slot Ethernet cradle
- Four slot battery charger
- Spare battery charging well in the back of either the XM5 USB single slot cradle or Ethernet cradle.

Charging Time

The standard capacity 4000mAh Li-ion battery pack requires five hours to charge.

4.18. Managing Main Battery Power



Data and files saved on the Mobile computer may be stored in RAM memory; therefore, maintain a continuous supply of power to the terminal to help prevent data loss. If the main battery pack is low, insert the terminal into a charging peripheral.

 **NOTE:** If the main battery is low and the terminal is in Suspend Mode, pressing the **Power** button does **not** wake the XM5 COMPUTER; you must replace the discharged battery with a fully charged battery or apply AC power to the terminal

Checking Battery Power

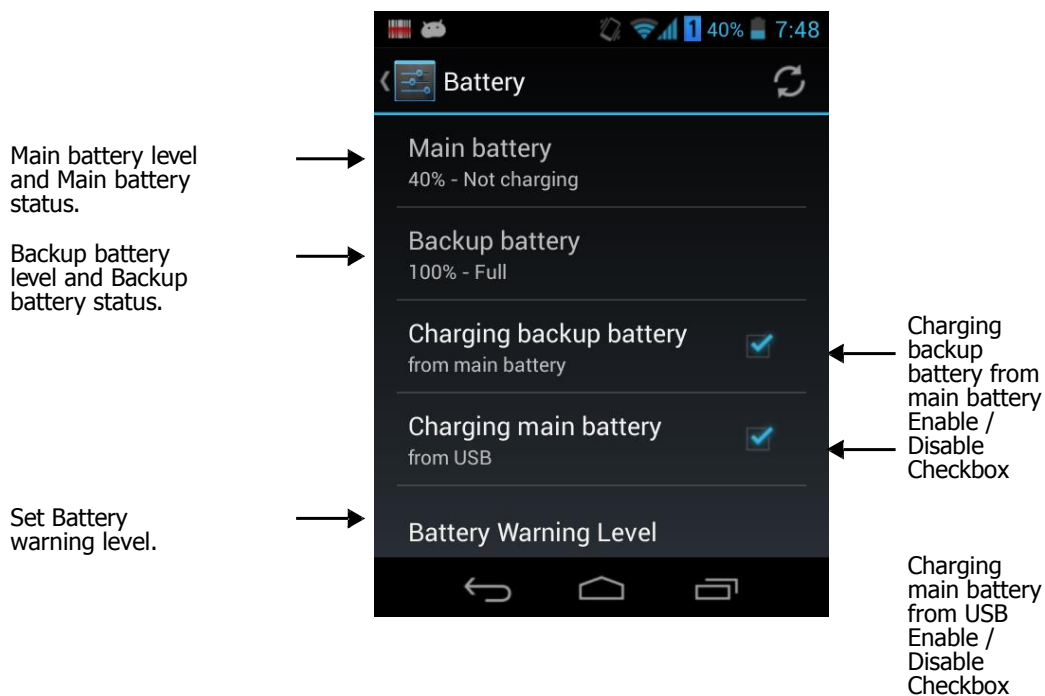
Tap app drawer > Settings > Battery > to open the Power Properties. The Battery tab opens displaying the charge status of the main battery.



 **NOTE:** Touch **All Apps**  > **Settings**  > **Battery** to display information on the **Main battery** status and **Backup battery** status (charging or discharging), the level (percentage) of charge remaining on the battery, and a breakdown of battery usage statistics for any running apps and services. Please set up the charging the Backup Battery from Main Battery or Main Battery from USB Cable. Also set the average of alert message of Low battery level or Critical low battery level using Battery Warning Level.

4.19. Resetting the Terminal

There are three types of system resets: a Soft Reset, a Hard Reset, or a Factory Reset. The soft and hard resets preserve all data stored in the file system. Contact a technical support representative for more information on how to perform a Factory Reset.

Soft Reset (Warm Boot)

A soft reset re-boots the terminal without losing RAM data, terminates all running applications, reloads the OS, and launches Autoinstall, which re-initializes any APK files in **\AutoInstall** folder.

You would perform a soft reset 1) when the terminal fails to respond, 2) after installing software applications that require a reboot, or 3) after making changes to certain system settings.

To perform a Soft Reset:

1. Press the Power button for 3 seconds and choose the **Reboot** on the power menu.
2. When the reset is complete, the Desktop appears.

Hard Reset (Cold Boot)



CAUTION: A hard reset erases all of the data and applications stored in RAM memory, reloads the OS, and launches Autoinstall, which installs any APK files in the **\AutoInstall**.

To Perform a Hard Reset:

1. Press and hold the Power button for 8 seconds until the terminal starts to re-boot.
2. When the reset is complete, the Desktop appears.

To perform a Hard Reset if the terminal has stopped responding, press and hold the Power button for 8 seconds until the terminal starts to re-boot.

4.20. Suspend Mode

Suspend Mode suspends terminal operation. The terminal appears to be “off” when in Suspend Mode. The terminal is programmed to go into Suspend Mode automatically when inactive for a specified period of time. You can set this time period in “Settings”, “Display”.

To suspend and resume operation, press the **Power** button. You may also press the front Scan key to wake a suspended device unless the battery door has been removed and replaced.



NOTE: You should always put the terminal in Suspend Mode when you change the battery pack; see [Changing the Battery Pack](#) on paragraph 4.17

Troubleshooting Suspend/Resume

If the terminal does not wake when you press the Power button, the main battery might be too low to resume operation. To check, remove the battery and install a fully charged battery or connect the terminal to an XM5 charging peripheral.

4.21. Memory Allocation

File storage and program memory are displayed in System Properties.

1. Touch **All Apps**  > **Settings**  > **Storage**.

4.22. Care and Cleaning of the Products

When needed, clean the image engine window and the LCD display with a clean, non-abrasive, lint-free cloth. The terminal can be cleaned with a damp cloth.

4.23. XM5 Technical Specifications

Model	XM5
Operating System	Android 4.2.2 (Jelly Bean)
Application Software	Tools and Demos
Processor	Cortex-A8 1GHz
Memory	512MB RAM X 1GB Flash
Storage Expansion	User accessible Micro SD memory card slot.
Display	3.5 in. transmissive active matrix 65K color LCD with backlight, VGA (480 x 640)
Scan Engine	1D engine: N4313 2D engine : N560x
Keypad	Numeric , Qwerty
Audio	Built-in microphone and speaker
I/O	High speed USB 2.0 from cradle (or I/O cable)
Battery	Li-ion battery 3.7V / 4000 mAh / 14.8 Wh
Expected Hours of Operation	8.5+ hours (with scan and continuously transmitting if using new standard Li-ion battery)
Charging	5V input through MicroUSB port.

Expected Charge Time	Capacity: 4000mAh – approx. 5 hours
Charging Peripherals	MicroUSB Adaptor Single Slot cradle–single-bay terminal charge/communicate Single Ethernet cradle–single-bay terminal charge/communication base (Via Ethernet connection) Quad Battery Charger
WPAN	Bluetooth Class II (10 m) v2.1 Enhanced Data Rate (EDR) with internal antenna.
WLAN	Dual Mode 802.11 a/b/g/n (11 Mbps/up to 72.2 Mbps) with internal antenna
WLAN Security	Wi-Fi Certified, 802.1X, WPA2, EAP, WEP, LEAP, TKIP, MSD, EAP-TLS, EAP-TTLS, WPAPSK, PEAP, CCXv4
WWAN	GSM: Quad band, 850/900/1800/1900MHz UMTS/HSPA: Five band, 800/850/900/1900/2100MHz
GPS	Stand alone & assisted GPS
NFC	13.56MHz HF, ISO14443A, ISO14443B & ISO15693 are supportive
Operating Temperature	-20° to 55°C
Charging Temperature	0~45°C (±3°C)
Storage Temperature	-25°C to 70°C
Humidity	95% humidity, non-condensing
Construction	High impact resistant PC/ABS housings Magnesium alloy internal chassis with component shock mounts
Drop	1.22m multiple drops to concrete, MIL-STD-810G, Method 516.6, 1.5m Procedure
Tumble	3.3 ft (1.0m) tumbles (500 drops)
ESD	Air: ± 15kV Direct: ± 8kV
Environmental	Independently certified to meet IP65 standards for moisture and particle resistance
Dimensions	H; 157.4mm x W; 74.2mm x L; 25.8mm(top)
Weight	1) 1D ; 330g (239g with battery) 2) 2D ; 330g (239g with battery)

5. Using the Keypad

5.1. Numeric Keypad Layout



5.2. Navigation Keys

Located in the center of the keypad for easy access with either hand, the navigation keys enable you to move the cursor up and down lines and from character to character.

5.3. Basic Keys

Name	Function
BLUE	Modifies the next key pressed to type specific functions.
Yellow	Toggles the keypad between alpha and numeric modes. Indicator changes accordingly on the command bar.
Send	Begin dialing. Start an action.
End	Hang up. Cancels an action.
ESC	Returns to closing stage of program and stage before
Tab	Moves to next control (Indent function to Text editor)
Backspace	Backspace moves the cursor back one space. If you are typing text, a character is deleted each time you press the backspace key.

Enter	Performs the same function as the Enter key on a workstation.
Power	Suspends and resumes the terminal.
Scan	Activates the image engine to scan a bar code or take an image.

5.4. Alpha/Numeric Modes

The command bar on the screen displays an icon that indicates the alpha/numeric status of the keypad.

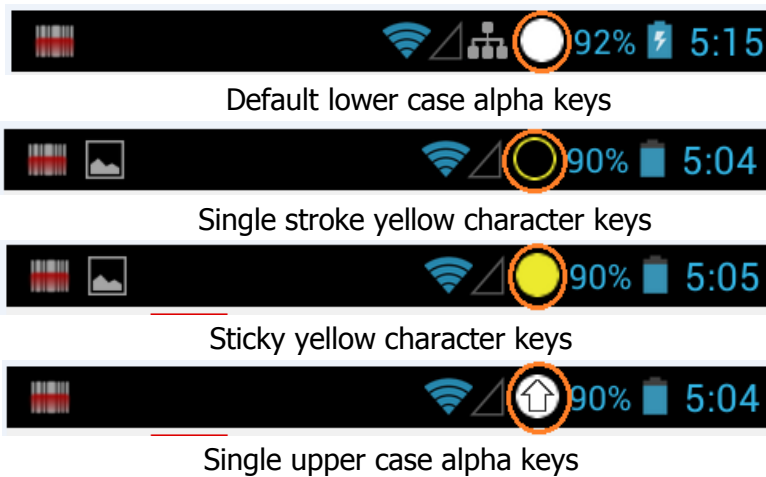

5.5. BLUE Key Combinations (Numeric Keypad)

Buttons can be programmed to execute different functions using the Program Buttons app in Tools. The following buttons on the XM5 are programmed for the listed function.

BLUE key modifies the next key pressed to perform specific functions.

Key Combination	Function
BLUE + 1	F1
BLUE + 2	F2
BLUE + 3	F3
BLUE + 4	F4
BLUE + 5	F5
BLUE + 6	F6
BLUE + 7	F7

BLUE + 8	F8
BLUE + 9	F9
BLUE + 0	F10
BLUE + #	Target key

5.6. Program Buttons

Buttons can be programmed to execute different functions using the Program Button program in the Control Panel. The following buttons on the MOBILE COMPUTER are programmed for the listed function.

Key Combination	Function
FSCAN	Do Scan
LSCAN	Do Scan
RSCAN	Do Scan
VOL+	Volume up
VOL-	Volume down
ESC	Esc Key
TAB	Tab Key
BACK SPACE	Bksp Key
ENTER	Return Key
DEL	Del Key
TARGET	BACKLIGHT
F1	No Action
F2	No Action
F3	No Action
F4	No Action
F5	No Action
F6	No Action
F7	No Action
F8	No Action
F9	No Action
F10	No Action

6. Using the Imager/Scan Engine

6.1. Overview

The XM5 COMPUTER contains an N560X 2D imager engine that instantly reads all popular 1D and 2D bar codes and supports omni-directional aiming and decoding or a N4313 1D laser engine that reads all popular 1D bar codes. The image engine can also capture digital images, such as signatures and pictures.

 **NOTE:** Performance may be impacted by bar code quality and environmental conditions.

 **NOTE:** Misreading may occur, if the bar code isn't positioned correctly. Recommended scanner beam positions are as follows:

N560X 2D imager

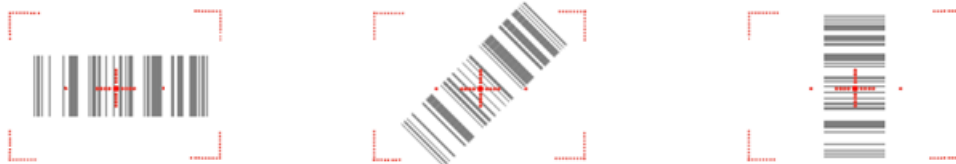

N4313 Laser scanning engine

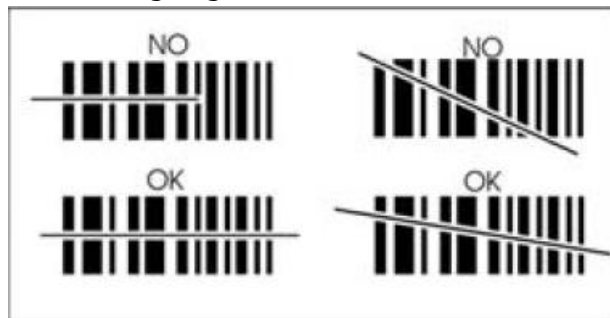

6.2. Depth of Field

Depth of Field for N560X

Focus	High Density (HD)			Standard Range (SR)			Extended Range (ER)		
	Near Distance (in/cm)	Far Distance (in/cm)	Delta (in/cm)	Near Distance (in/cm)	Far Distance (in/cm)	Delta (in/cm)	Near Distance (in/cm)	Far Distance (in/cm)	Delta (in/cm)
3 mil C39/128	2.2 (5.6)	3.1 (7.9)	.9 (2.3)	-	-	-	-	-	-
5 mil C39/128	1.6 (4.1)	4.5 (11.4)	2.9 (7.4)	3.0 (7.6)	6.1 (15.5)	3.1 (7.9)	5.8 (14.7)	8.8 (22.4)	3.0 (7.6)
7.5 mil C39/128	1.8 (4.6)	5.0 (12.7)	3.2 (8.1)	2.4 (6.1)	8.4 (21.3)	6.0 (12.2)	4.4 (11.2)	13.0 (33.2)	8.6 (21.8)
10 mil C39/128	1.7 (4.3)	5.1 (13.0)	3.4 (8.6)	1.9 (4.8)	12.0 (30.5)	10.1 (25.7)	3.2 (8.1)	16.1 (40.9)	12.9 (32.8)
15 mil C39/128	1.4 (3.6)	7.6 (19.3)	6.2 (15.8)	2.2 (5.6)	17.9 (45.5)	15.7 (40.0)	2.0 (5.1)	19.0 (48.3)	17.0 (43.2)
20 mil C39/128	2.7 (6.9)	8.6 (21.8)	5.9 (15.0)	2.8 (7.1)	17.8 (45.2)	15.0 (38.1)	3.1 (7.9)	22.8 (57.9)	19.7 (50.0)
100% UPC	2.2 (5.6)	6.7 (17.0)	4.5 (11.4)	2.1 (5.3)	15.0 (38.1)	12.9 (32.8)	2.8 (7.1)	19.0 (48.3)	16.2 (41.2)
5 mil PDF417	1.7 (4.3)	4.2 (10.7)	2.5 (6.4)	3.0 (7.6)	4.5 (11.4)	1.5 (3.8)	6.1 (15.5)	7.4 (18.8)	1.3 (3.3)
6.7 mil PDF417	1.7 (4.3)	4.7 (11.9)	3.0 (7.6)	2.5 (6.4)	6.6 (16.8)	4.1 (10.4)	4.7 (11.9)	9.8 (24.9)	5.1 (13.0)
10 mil PDF417	1.8 (4.6)	5.6 (14.2)	3.8 (9.7)	1.7 (4.3)	10.5 (26.7)	8.8 (22.4)	2.4 (6.1)	14.9 (37.8)	12.5 (31.8)
5 mil MicroPDF	1.8 (4.6)	3.2 (8.1)	1.4 (3.6)	-	-	-	-	-	-
5 mil Data Matrix	2.0 (5.1)	3.0 (7.6)	1.0 (2.5)	-	-	-	-	-	-
10 mil Data Matrix/Aztec	1.7 (4.3)	4.7 (11.9)	3.0 (7.6)	2.9 (7.4)	7.3 (18.5)	4.4 (11.2)	5.3 (13.5)	10.0 (25.4)	4.7 (11.9)
20 mil Data Matrix	1.7 (4.3)	7.0 (17.8)	5.3 (13.5)	2.9 (7.4)	14.2 (36.1)	11.3 (28.7)	4.0 (10.2)	16.0 (40.6)	12.0 (30.5)
10 mil QR	1.2 (3.0)	4.7 (11.9)	3.5 (8.9)	2.6 (6.6)	6.9 (17.5)	4.3 (11.0)	4.3 (10.9)	10.4 (26.4)	6.1 (15.5)
20 mil QR	2.2 (5.6)	7.2 (18.3)	5.0 (12.7)	2.0 (5.1)	15.0 (38.1)	13.0 (33)	2.1 (5.3)	17.7 (45.0)	15.6 (39.6)
32 mil Maxicode	2.2 (5.6)	8.3 (21.1)	6.1 (15.5)	2.9 (7.4)	15.3 (38.9)	12.4 (31.5)	4.2 (10.7)	17.7 (45.0)	13.5 (34.3)

 **NOTE:** Test Condition: Room Temperature (Approx. 23°C), 0 Lux.

6.3. Supported Bar Code Symbologies for 560X

Symbology Type	Symbology Name
1D Symbologies	Codabar Code 11 Code 128 Code 39 Code 93 / 93i EAN-8 EAN-13 Interleaved 2 of 5 Reduced Space Symbology UPC-A UPC-E MSI Trioptic Code Code 32 Pharmaceutical (PARAF) Matrix 2 of 5 Telepen GS1-128 ISBT 128 Straight 2 of 5 (Industrial) UPC-A (Coupon Code) UPC-E1 Straight 2 of 5 (IATA)
2D Symbologies	Aztec Code Data Matrix MaxiCode MicroPDF417 PDF417 QR Code and Micro QR Code Han Xin
Composite Codes	EAN.UCC Composite Codablock F TCIF Linked Code 39 (TLC39)
OCR	OCR
Postal Codes	Postnet British Post(BPO) Canadian Post Australian Post Japanese Post Planet Code KIX (Netherlands) Post China Post Korea Post 4-CB(4-State Customer Barcode) ID-Tag(UPU 4-State)

6.4. **Activating the Imager/Scanner**

When a scanning application is open, press the **Scan** key to activate the imager/scanner.

6.5. **Using Demos**

The XM5 comes preloaded with apps to demonstrate certain features of the device. There are two Demos that feature the imager/scanner engine: Image Demo and Scan Demo.

To access these demos, tap **All Apps**  > **Demos**.

- Select **Scan Demo** to verify decoding, or
- Select **Image Demo** to verify imaging (not available on device using the N4313 laser engine).

6.6. **Decoding**

The XM5 supports Full-area Imaging decode mode.

Full-area Imaging

With full-area imaging the XM5 supports omni-directional aiming meaning that a positive read can be obtained from many positions. For details, see Omni-Directional Scanning Positions (paragraph 6.10).

6.7. **To Decode a Bar Code**

1. Tap **All Apps**  -> **Demos** -> **Scan Demo**.
2. Position the XM5 over one of the Sample Bar Codes (paragraph 6.9).
A range of 4–10 inches (10–25 cm) from the bar code is recommended.
3. Project the aiming brackets by pressing and holding the **Scan** key. The Scan LED lights red.
4. Center the aimer crosshair over the bar code. The aiming beam should be oriented in line with the bar code to achieve optimal decoding; Omni-Directional Scanning Positions (paragraph 6.10).
5. When the bar code is successfully decoded, the decode LED lights green and the terminal beeps.

6.8. Sample Bar Codes

Barcodes to verify decoding:



6.9. Omni-Directional Scanning Positions

The high-vis aiming pattern frames the bar code to provide you with the best scanning performance.

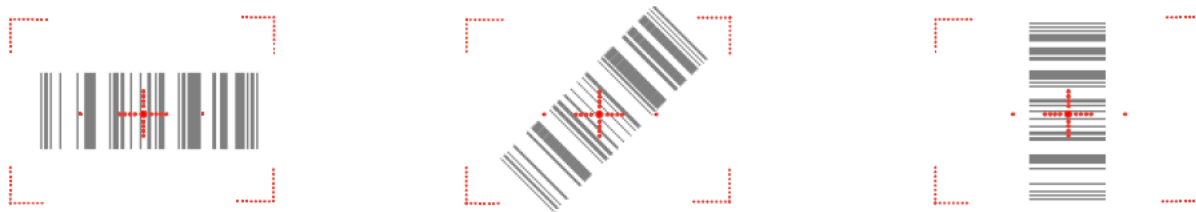

 **NOTE:** To achieve the best read, the aiming beam should be centered horizontally across the bar code.

The aiming pattern is smaller when the terminal is held closer to the code and larger when the terminal is held farther from the code. Barcodes with smaller bars or elements (mil size) should be read closer to the unit whereas larger bars or elements (mil size) should be read farther from the unit.

6.10. Capturing Images

The image-capture process is an intuitive, split-second operation for experienced users. By following basic guidelines, however, new users can easily develop their own technique and, with practice, quickly learn to adapt to different application environments.

Image Preview

When the imaging process is initiated, the touch screen displays a preview of the object. This is a live video image of what the imager is currently viewing and has a slightly degraded appearance compared to the captured image. This is normal; the captured image has a higher resolution.

File Formats

The XM5 supports BMP file format only.

7. Using the Laser Scanner

7.1. Overview

The XM5 (N4313 laser version) reads all popular 1D bar codes. See Overview (paragraph 6.1).

 **NOTE:** Performance may be impacted by bar code quality and environmental conditions

7.2. Depth of Field

Depth of Field for N4313

Code Size	Reference Range	
	Near Distance (in/cm)	Far Distance (in/cm)
Code 39 4 mil	5in / 12.7cm	5.4in / 13.8cm
Code 39 5 mil	4.1in / 11.7cm	7.2in / 18.4cm
Code 39 7.5 mil	4.1in / 10.4cm	10.7in / 27.4cm
Cede 39 10 mil	3.4in / 8.7cm	14.5in / 36.9cm
UPC 13 mil, 100%	1.9in / 4.7cm	16.8in / 42.8cm
Code 39 15 mil	1.9in / 4.7cm	19.9in / 50.4cm
Code 39 20 mil	(*)	25.5in / 64.6cm
Code 39 40 mil	(*)	26.7in / 67.5cm
Code 39 55 mil	(*)	31.8in / 80.8cm

 **NOTE:** Test Condition: Room Temperature(Approx. 20°C), 450 ~ 500 Lux.

 **NOTE:** * = dependent on width of bar code.

7.3. Supported Bar Code Symbologies

Symbology Type	Symbology Name	
1D Symbologies	Codabar	UPC A
	Code 39	UPC E
	Interleaved 2of 5	EAN 13
	Nec 2of5	EAN 8
	Code 93	MSI
	Straight 2of5 Industrial	Plessey
	Straight 2 of 5 IATA	GS1 Databar Omnidirectional
	Matrix 2 of 5	GS1 Databar Limited)
	Code 11	GS1 Databar (Expanded
	Code 128	China Post
	GS1 128	Trioptic
	Telepen	

7.4. Activating the Laser Scanner

When a scanning application is open, press the Scan key to activate the laser scanner.

7.5. Using Demos

XM5 demos are software utilities loaded on Mobile computers that demonstrate the advanced features of the terminal.

To access these demos, tap **All Apps**  > **Demos**

- Select **Scan Demo** to verify decoding

7.6. Decoding a Bar Code

1. Tap **All Apps**  > **Demos** > **Scan Demo**.
2. Position the Mobile computer over one of the Sample Bar Codes on paragraph 7.8.
A range of 4-10 inches (10-25 cm) from the bar code is recommended.
3. Project the aiming beam by pressing and holding the **Scan** key. The Scan LED lights red.
4. Center the aimer beam horizontally over the bar code and highlight all of the vertical bars of the bar code.
6. When the bar code is successfully decoded, the decode LED lights green and the terminal beeps.

7.7. Sample Bar Code

You can use the following bar code to verify decoding:



7.8. Scanning Positions

The aiming beam must be aimed across the entire bar code to provide the best scanning performance. The aiming pattern is smaller when the terminal is held closer to the code and larger when the terminal is held farther from the code. Barcodes with smaller bars or elements (mil size) should be read closer to the unit whereas larger bars or elements (mil size) should be read farther from the unit.





8. Using ScanWedge

8.1. Overview

ScanWedge sends data from the installed scan engine(N4313 or N560X) to the foreground application as keystrokes or clipboard. The foreground application is the open software application whose window is currently active on the display.

8.2. ScanWedge Enable/Disable

ScanWedge is enabled by default on the XM5.

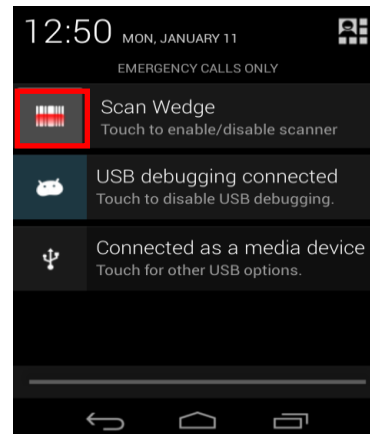
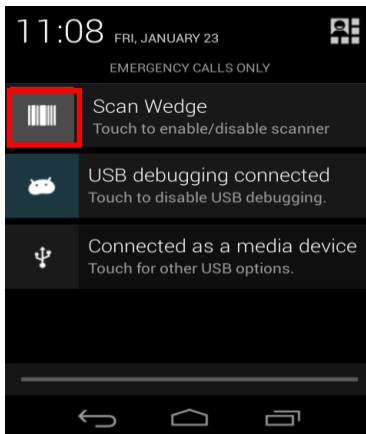

To enable or disable, tap/touch the barcode icon  (disabled)→ (enabled) on the Notification Panel.



9. Using Control Panel

9.1. Settings

Overview

Settings allows you to verify and/or alter system parameters to customize your terminal to meet your specific needs. Touch **All Apps**  > **Settings**  or pull down the notification panel, and then touch the quick settings icon .

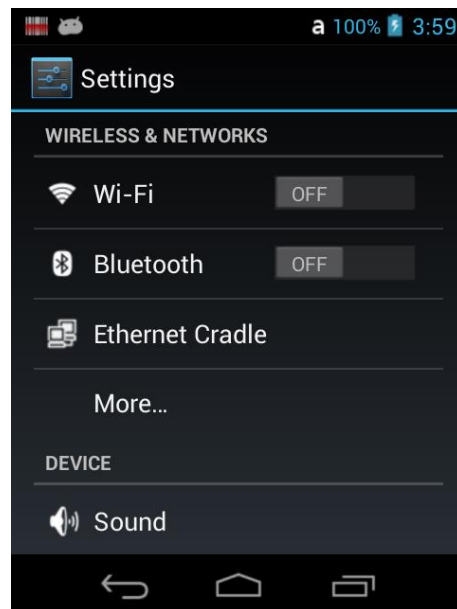

9.2. Wireless & Networks Settings

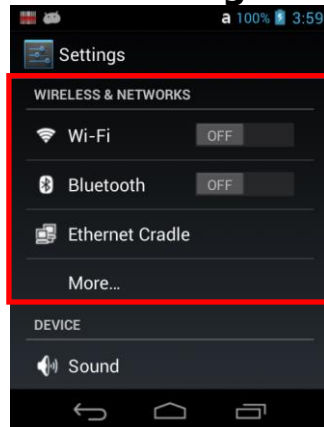



Under the **Wireless & Networks** heading on the **Settings** screen there are options for turning the on board wireless radios in the terminal on or off and for configuring network connections.

See 10.7.1. [Wi-Fi Network Connections](#) and 11. [Bluetooth Handler](#)

9.3. Ethernet Cradle Settings

Shows the network information to connect to Ethernet Cradle. (IP Address, NetMask, Gateway, DNS1, DNS2, Hardware address)
It can be set to Automatic IP or Static IP on the Connection.

NOTE: The cradle Ethernet connection shows this icon  on the status bar.
Also if Ethernet is connected, icon is changed to 



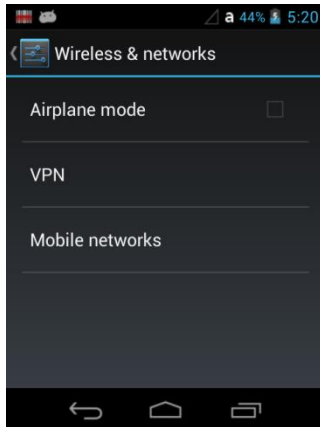

9.3.1. More...



Airplane Mode

Turn On Airplane mode to disable all the XM5 radios that transmit voice or data.

NOTE: Another way is to touch and hold the status bar, and then drag down to open the **Notification Panel** and touch the  button on the top right of the Notifications panel. Touch  next to **Airplane Mode**.
When Airplane Mode is turned on,  shows on the status bar.

Virtual Private Networks (VPN)

To complete the VPN setup screens, ask your ISP or network administrator for the proxy server name, server type, port, type of Socks protocol used, and your user name and password if you do not already have the information.

Adding a VPN:

1. Touch **All Apps** > **Settings** .
2. Under **Wireless & Networks**, touch **More** > **VPN**.



NOTE: VPN connections require you to set a screen lock PIN or password before you can use credential storage. If you have not set either security option, select **OK** on the pop-up notification window, and then set a screen lock PIN or password. Once you complete the process, you are automatically directed back to the VPN screen.

3. Touch **Add VPN network**.
4. Enter the VPN **Name**, and then select the VPN **Type** you want to add. Complete the remaining data fields with the appropriate information for your network. The terminal supports the following protocol types:
PPTP, L2TP/IPSec PSK, L2TP/IPSec RSA, IPSec Xauth PSK, IPSec Xauth RSA, IPSec Hybrid RSA

5. Touch **Save**.

NOTE: To delete a VPN, touch and hold the network name, and then touch **Delete Network**.
To edit a VPN configuration, touch and hold the network name on the **VPN** screen, and then touch **Edit network**. Touch **Save** to retain your changes.

Connecting to a VPN:

1. Touch **All Apps**  > **Settings** .
2. Under **Wireless & Networks**, touch **More** > **VPN**.
3. Touch the name of the VPN.
4. Enter any security credentials (e.g., password, user name, certificate information or server name) required by the VPN.
5. Touch **Connect**.

NOTE: When a VPN connection is established, a  shows in the status bar.

Disconnecting from a VPN:

1. Drag the status bar down from the top of the touch screen to view the Notification panel.
2. Touch the VPN connection notification to disconnect.

Mobile Networks

- APN: it is shown the APN list to use currently. If new APN is added, please put the new APN on the Menu button  of the top of the right

NOTE: The Access Point Name (APN) is the name for the settings your phone reads to set up a connection to the gateway between your carrier's cellular network and the public Internet.

9.4. Device Settings

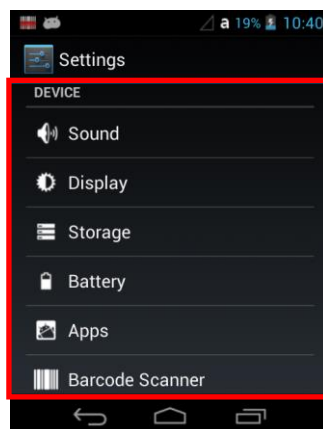



9.5. Sound Setting

Touch **Sound** from the **Settings**  screen then select the configuration setting you want to modify.

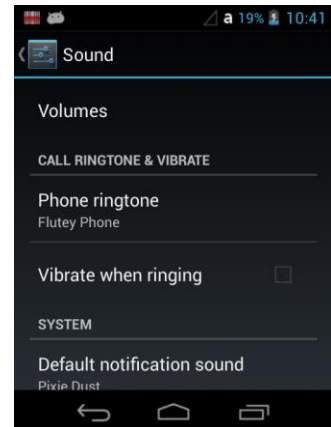
- **Volumes** - Set the volume level used for music, videos, games, other media, ring tones, notifications, and alarms.
- **Call Ringtone & Vibrate** - Set the phone ringtone, and turn vibration on or off for incoming calls.
- **System**- Set the Default sound for notifications and on/off the Dial pad touch tones, Touch sounds and Screen lock sound.



9.6. Display Settings

Touch **All Apps**  > **Settings**  > **Display** from the screen to set the touch screen **Brightness** level, **Turn keyboard backlight** on or off, **Wallpaper**, turn **Auto-rotate screen** on or off, adjust the touch **Screen timeout** settings, set the on display **Wakeup Source**, set the on screen **Font size**, and enable or disable **Power**  button functions.

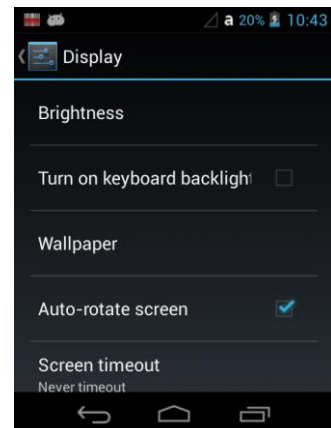

Turn on keyboard backlight

To turn on the keypad backlight, check the checkbox.

The duration of the keypad backlight synchronizes with the LCD backlight setting.

Auto-rotate screen

By default, the display automatically adjusts the orientation of the screen between landscape and portrait when the terminal is rotated. Touch the **Auto-rotate screen** checkbox to toggle the option on or off.

Screen timeout

The **Screen timeout** setting enables you to customize backlight functionality for the display. Select how many minutes or seconds you want to elapse before the backlight automatically turns off and the terminal enters **Suspend** mode.

Wakeup Source

Allows setting of wakeup condition.

Font size

To adjust the font size on the system.

9.7. Storage Settings

Touch **Storage** from the **Settings**  screen to view use and space statistics for the internal storage on the terminal and the installed SD card.

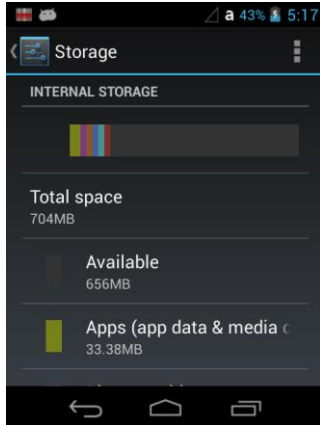

9.8. Battery Settings

See 4.18 Managing Battery Power

9.9. Apps Settings

Touch **Apps** from the **Settings**  screen to view, evaluate, and modify how applications installed on the terminal utilize memory and storage resources.

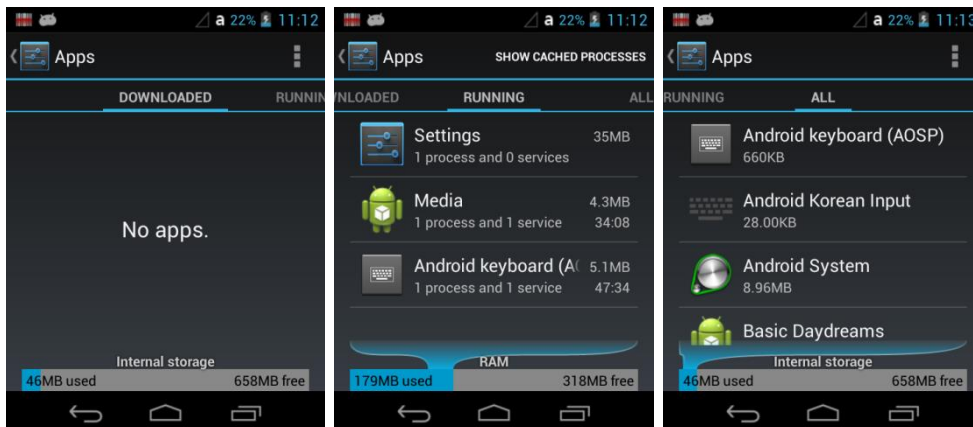

Touch the tabs at the top of the **Apps** screen to view lists organized into three categories:

Downloaded

Displays all apps downloaded to the terminal.

To sort the list, press the **Menu** button  at the top of the screen, and then touch **Sort by size** or **Sort by name** or touch the Reset app preferences to reset the App environment setting.

Running

Displays application processes and services running on the terminal and cached background processes. Touch **Show cached processes** or **Show running services** at the top of the screen to switch between the lists.

All

All apps are stored on the internal storage of the terminal. To sort the list, press the **Menu** button  at the top of the screen, and then touch **Sort by size** or **Sort by name**, or touch the Reset app preferences to reset the App environment setting.

Displayed at the bottom of each category screen is the memory or storage type, the amount of storage or memory used by the listed applications, and the amount of free space remaining.

Managing Apps

The **App info** screen contains detailed statistics on an app including the amount of storage or cache utilized, default launch settings, and access permissions granted to the app. Statistics useful when troubleshooting slow terminal performance, low memory issues, or an unresponsive application. The **App info** screen also provides access to perform the following actions:

- force stop the app,
- uninstall the app,
- show notifications,
- clear stored data,
- clear cache, or
- clear any Launch by default settings assigned to the app.

To access the **App info** screen, touch the app name on the list displayed under the **Downloaded** tab on the **Settings > Apps** screen

Uninstall Applications

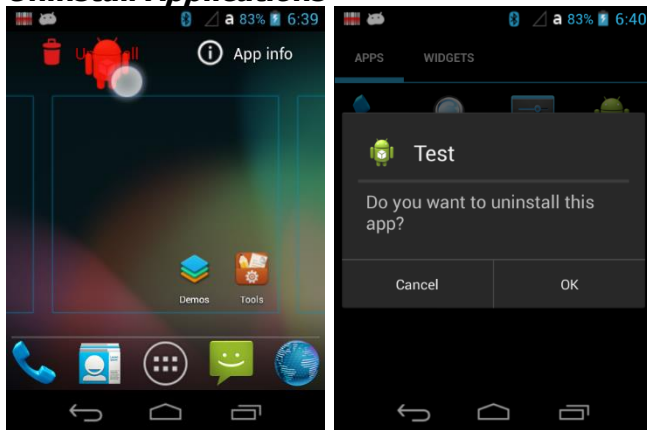

1. Locate the app to uninstall, tap and drag the application to the uninstall Android trash can.
2. Touch the **OK** button to confirm.

Stop Application Processes or Services

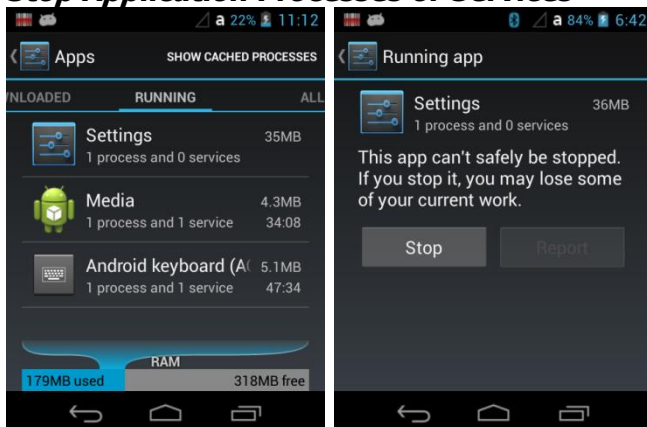

1. Touch **Apps** from the **Settings** screen.
2. Touch the **Running** tab.
3. Touch the cached background process or running service you want to stop.

4. Touch **Stop**.

9.10. Barcode Scanner Settings

Change the ScanSetting

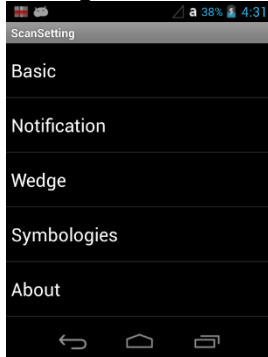

Tab	Section	Option	Description
Basic	Scanning	Trigger timeout (sec)	Specifies the trigger time out in seconds. If a barcode is not decoded within the specified timeout, the default Notifier indicates that decoding is failed
		Enable Auto Scan	Enable Auto Scan with specified interval.
		Auto Scan interval (sec)	Set Auto Scan interval time.
		Enable Continuous Scan	Enable Continuous Scan without any interval.
		Enable Center Window (IT5300SR device only)	Enable Center window. Bar codes are decoded only if they are within the specified windows
		Decode Mode(IT5300SR device only)	Standard: Quick Omni (<i>By default</i>):
		Delay Before Decoding(IT5300SR device only)	Start to decoding after specified milliseconds Values: 0(default), 100, 200, 300, 400, 500, 600, 700, 800, 900, 1000
		Default Enable	Enable/Disable scanner when the device starts

	Wedge mode	Result Type	Select Result Type : Keyboard Event Clipboard(default)
		Terminator	Select the desired barcode end method from the pull down list. Values: None, CRLF, Space
	Power Save Options (N4313 device only)	Power Save TimeOut (sec)	1~65535
Notification	Beep If enabled – plays audio sound	Enable Beep	Set enable/disable plays audio sound.
		Good read	Set sound to indicate good read.
		Bad read	Set sound to indicate bad read.
	LED	Enable LED	Set enable/disable visual scan indicators.
	Vibrator If enabled - Turn on LED for good/bad scan indicator	Enable Vibrator	Set enable/disable vibrator operation.
		Good read	Set vibration time after good read.
Bad read		Set vibration time after bad read.	
Wedge	Barcode ID	Transmit Barcode ID	Enable to transmit predefined barcode ID in Detail tab
	Label	Prefix	Enter Prefix to be sent prior to the decoded/received data.
		Suffix	Enter Suffix to be sent after the decoded/received data
Symbologies	Select barcode types you want to read There is "Enable All" and "Disable All" to enable/disable all symbologies		

Tab	Section	Option	Description
About	Specifies Barcode engine type, Firmware revision, Decider revision, API revision		
	Factory Default	Load Factory Default	After modifying the current settings, if you wish to return to the factory defaults, tap the Load Factory Default button.

9.11. Personal Settings

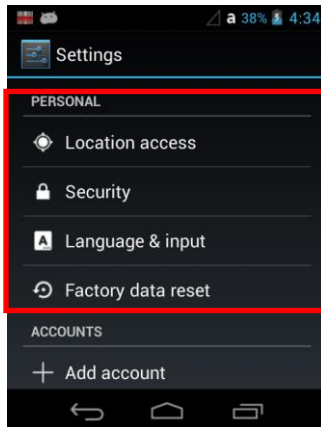

9.12. Location access Settings

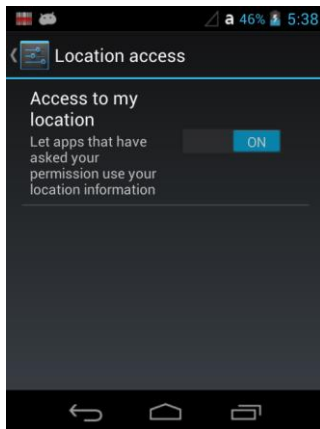

Toggle on/off the “Let apps that have asked your permission use your location information”.

9.13. Security Settings

Touch **Security** from the **Settings**  menu to manage terminal security parameters (e.g., authorization for device administration, setup a screen lock, setup a SIM card PIN, enable/disable visible passwords, load security certificates, and setup a password to protect the terminal's credential storage).

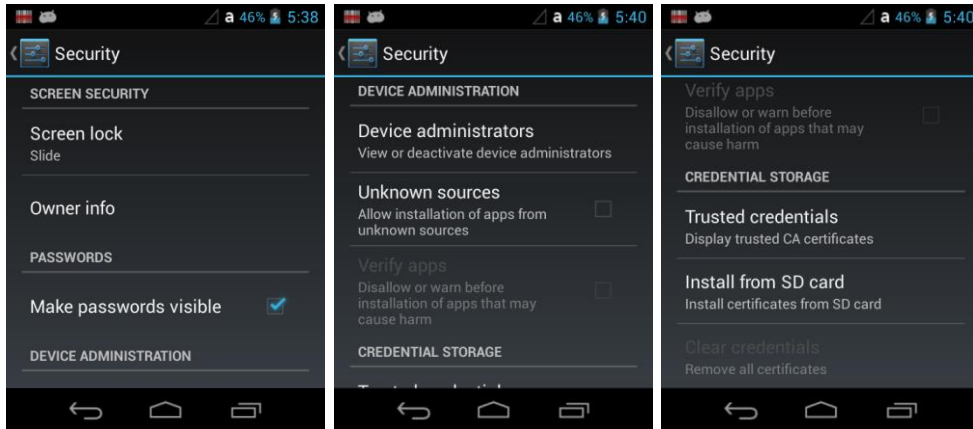

Screen Security

The **Screen Lock** settings provide access to additional security features that enable you to prevent an unauthorized person from unlocking the touch screen and accessing the terminal. Select from five security options: **None, Slide, Pattern, PIN or Password**.

To enable a screen lock:

Touch on **Pattern, PIN or Password** to access additional dialogue screens that step you through setting up or updating the security feature.

To disable a screen lock:

Touch **Security** from the **Settings** screen. Select **Screen Lock**, and then enter your existing Pattern, PIN, or Password. Touch **Next** and then select **None** to remove the security setting.

Once you have established a screen lock, additional settings may appear under the **Screen Security** heading depending on the type of security you implemented. The additional settings allow you to adjust the time increment for the screen to **Automatically lock** after entering.

Turn On **Power button instantly lock** to lock immediately on power ON.

The **Owner Info** setting allows you to designate custom text you want displayed on the lock screen. You can also disable owner information from displaying

SIM card lock

Touch **Set up SIM card lock** to establish or modify a SIM card PIN so unauthorized individuals cannot use the terminal as a phone or modify data on the SIM card

Passwords

Touch the **Make passwords visible** checkbox to toggle between hiding or showing passwords as you type.

Device Administration

The **Device administrators** screen lists all applications that have been given authorization to act as a device administrator, which is often required when you set up accounts that

synchronize data between the terminal and an enterprise service. An enterprise service implements security policies on the terminal before allowing a connection (e.g. passwords and certificates). Touch **Device administrators** from the **Security** screen, and then touch the application name if you want to remove authorization for the app to act as a device administrator for the terminal.

Check the **Unknown sources** box to allow the installation of non-market applications. This setting is disabled by default.

Credential Storage

Access options that help you manage your Wi-Fi network and/or Virtual Private Network (VPN) security certificates under the **Credential storage** heading at the bottom of the **Security** settings screen.

 **NOTE:** Android supports DER-encoded X.509 certificates saved with a .crt or .cer file extension and X.509 certificates saved in PKCS#12 key store files with a .p12 or .pfx file extension.

Trusted credentials

Touch **Trusted credentials** from the **Security** screen to view all the security credentials installed on the terminal. Tabs organize the certificates into two categories: **System** and **User**. Touch the certificate name to view additional details about the certificate.

To disable a system certificate or remove a user certificate:

1. Touch the certificate name from the **Trusted credentials System** or **User** list.
2. Scroll to the bottom of the Security certificate details screen.
3. Touch **Disable** or **Remove** depending on the type of certificate you are viewing.

 **NOTE:** System certificates can be Enabled using the same method at a later date but User certificates are permanently deleted.



4. Select **OK**

Install from SD Card

To install encrypted certificate from the SD card installed in the terminal:

1. Copy the certificate from the host device (computer) to the root directory of the SD card.

 **NOTE:** Ensure your certificates are saved with the correct file extension. Android supports DER-encoded X.509 certificates saved with a .crt or .cer file extension and X.509 certificates saved in PKCS#12 key store files with a .p12 or .pfx file extension.

2. Touch **All Apps**  > **Settings**  > **Security** > **Credential Storage**.
3. Touch **Install from SD card**.
4. Touch the file name of the certificate to install and enter a password if required.
5. Touch **OK**.
6. Enter the name of the certificate, and then touch **OK**.

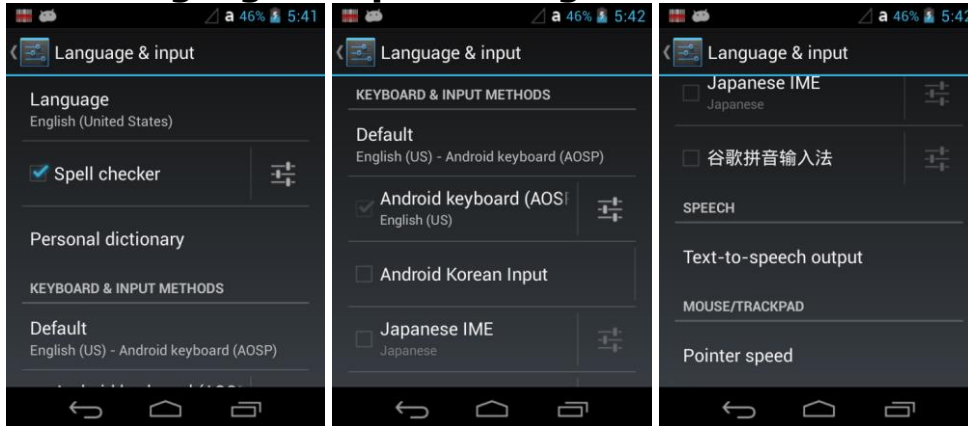

NOTE: Once an encrypted certificate is installed on the terminal, it is automatically deleted from the SD card.

9.14. Language & input Settings



Touch **Language & input** from the **Settings** screen to access options to modify the default language for the display, change the automatic spelling correction settings, manage your personal dictionary, configure keyboard & input methods for text entry, manage speech settings for voice searches and text-to-speech output and set the mouse/trackpad pointer speed

Language



Touch **All Apps**  > **Settings**  > **Language & input** > **Language**, and then select the language you want displayed on the touch screen.

Spelling checker

Touch **All Apps**  > **Settings**  > **Language & input** > **Spelling correction** to turn the feature on or off.

Touch  to change the language settings when the feature is turned on.

Personal Dictionary

Touch **All Apps**  > **Settings**  > **Language & input** > **Personal Dictionary** to add, edit, or delete words from your personal dictionary.

Keyboard & Input Methods

The enhanced virtual keyboard appears when you open an application or select a field that requires text or numerical input. The content of the keyboard may vary depending on the selected default, the application in use, and the input field requirements.

To modify the default method for entering text:



1. **Touch** All Apps  > Settings  > **Language & input** > **Default**.

2. Select an input method **Android Keyboard** or **Enhanced Keyboard**.



NOTE: XM5 terminals are shipped from the factory configured to use the **Android Keyboard(AOSP)** as the default input method.

Touch  next to the keyboard name to adjust settings specific for the keyboard type (e.g., Keyboard Skin, Vibrate on Key Press, Sound on Key Press, Show Key Preview, Show Settings Key, and Input Language Preference).

Speech

To configure **Voice Search** settings, touch **All Apps**  > **Settings**  > **Language & input** > **Voice Search**. The settings screen provides access for you to:

- Set the default Language used for voice searches.
- Set SafeSearch sensitivity levels to filter explicit images when using Google Voice Search.
- Enable/Disable offensive language blocks for voice results.
-

To configure **Text-to-speech (TTS)** settings, touch **All Apps**  > **Settings**  > **Language & input** > **Text-to-speech output**. The settings screen provides access for you to:

- Select and configure the preferred engine used for speech synthesis when you want to hear text read aloud.
- Adjust the Speech rate of the synthesized voice.
- Listen to an example of speech synthesis based on the current settings.

Mouse/Trackpad

Touch **All Apps**  > **Settings**  > **Language & input** > **Pointer Speed** to adjust the sensitivity and speed of the touch screen response to your finger swipe.

9.15. **Factory data reset**

Returns the XM5 to factory defaults by removing all custom settings, data and applications.

9.16. **Accounts Settings**

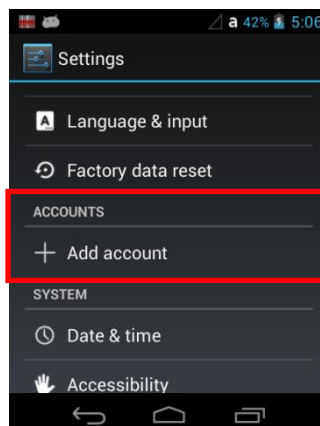

Touch **Accounts** from the **Settings** screen to add, remove, and manage exchange accounts (e.g., e-mail) and allow apps to automatically schedule and sync data.

To add an account:



Touch All Apps  > Settings  > Accounts

Touch Add account.

Touch the type of account to add.

1. Follow the on-screen instructions to enter the required information for the account type selected. You may need to provide a user name and password, select security settings, and configure data sync preferences during the setup.
2. The account appears on the Accounts list when setup is complete. Depending on the settings you selected during the account configuration, your terminal may automatically start to sync account data (e.g., email, contacts, music and calendar).

To remove an account:

1. Touch **All Apps**  > **Settings**  > **Accounts > Your Account**
2. Touch the account to delete.
3. Press the **Menu** button  *at the top of the screen* and then select **Remove account**.
4. Touch **Remove account** to confirm deletion.

9.17. System Settings

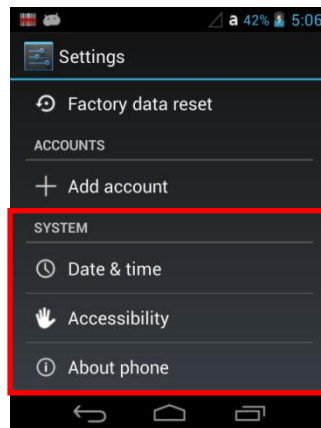

9.18. Date & Time Settings

Touch **Date & time** from the **Settings**  screen to access options to configure the date, time, time zone, time format, and date format displayed on the terminal. You can set the terminal to synchronize the date and time using a network connection by checking the **Automatic date & time** box or you can manually enter the values by touching **Set date**, **Set Time**, or **Select Time zone**.

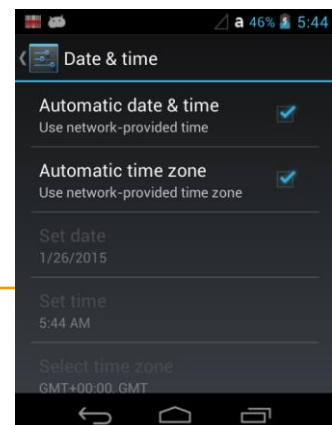

NOTE: If the Automatic option is checked, the **Set date**, **Select Time zone**, and **Set time** menu options are grayed out.

To modify how the time is displayed on the screen, check the **Use 24-hour format** box to switch from a 12-hour cycle to a 24-hour cycle. In a 24-hour time cycle, 1:00 pm displays as 13:00 pm.

To change the date format displayed on the screen, touch **Select date format**, and then select a format from the list.

9.19. Accessibility Settings

Touch **Accessibility** from the **Settings**  screen to configure features that make using the terminal easier for people with certain physical disabilities.

System

Under the **System** heading on the **Accessibility** screen, additional options are available to enable or disable Large Text, speak passwords, or ending calls using the **Power** button . You can also set Touch & hold delay settings and permissions for installing web scripts.

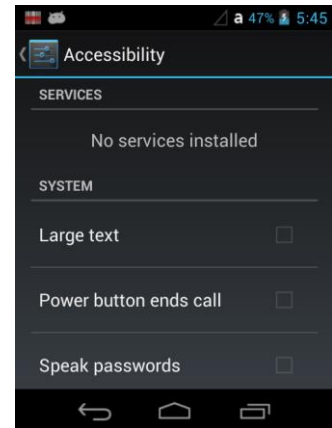

9.20. Developer options

Touch **Developer options** from the **Settings**  screen to access advanced settings used by Android application developers. For information on these settings, Android APIs, and development tools, refer to the Android developer web site at <http://developer.android.com>.

9.21. About Phone

The **About Phone** screen displays specific information about the terminal including: Model number, Android version, Baseband version, Kernel version, and Build number.

Touch **System Updates** to view the last time the Android operating system was updated or to manually initiate an Android update.

Touch **Legal information** to view important information on Open source software licenses.

10. Communication

10.1. Communication Options

The XM5 offers several communication options including USB and wireless radios.

USB Connector

The XM5 has a MicroUSB connector located at the base of the unit that provides USB v4.0 High speed communications with a maximum transfer rate of 480 Mbps.

Wireless Radios (Wireless Communication)

The XM5 can be equipped with an 802.11a/b/g/n/Bluetooth radio and WWAN.

For more information, see Wireless Radios on paragraph 10.14.

10.2. Connect to a Windows computer via USB

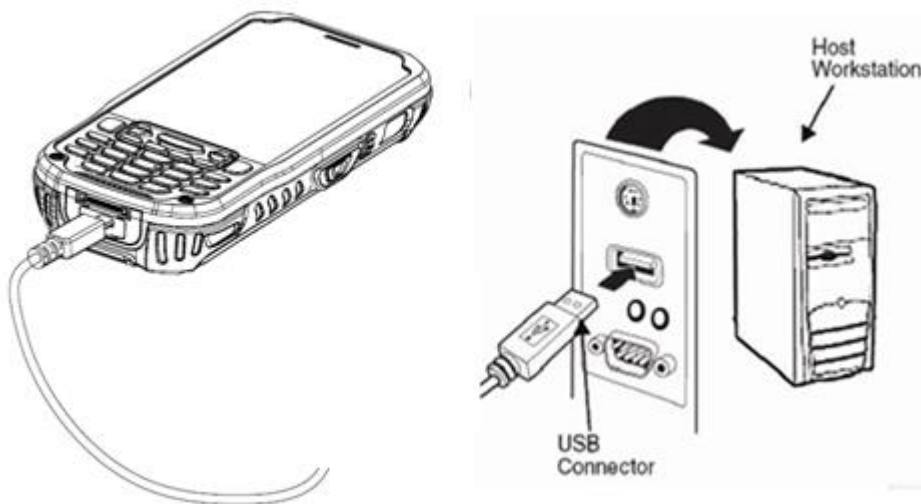

Use the USB cable to connect your XM5 to a Windows computer and transfer music, pictures, and other files in both directions.

When you connect your XM5 to the USB port on your computer, it is treated as a mass storage device, and transferring files is as simple as dragging and dropping or copying and pasting as you would for moving files between folders on your PC.

10.3. Wireless Radios

There are four radio options: 802.11 a/b/g/n Bluetooth, Phone and GPS.

1. **802.11 a/b/g/n** (WLAN configuration): Integrated Wi-Fi (802.11a/b/g/n Radio), up to 72.2Mbps
2. **Bluetooth** (WPAN configuration): Integrated Bluetooth v2.1+EDR
3. **Phone** (WWAN configuration): 3G WWAN HSPA Module
4. **GPS**: Module inherent to HSPA Module
5. **NFC** : 13.56MHz HF, ISO14443A, ISO14443B & ISO15693 are supported.

 **NOTE:** XM5 does not provide all Bluetooth profiles.

10.4. Connecting the Terminal to a Wireless Network

You connect the XM5 to a wireless network through the on-board radio (802.11a/b/g/n, Bluetooth and/or Phone).





Each radio has its own configuration program and requires specific information about the wireless network to connect. Successful connection depends on your network infrastructure about which you will need specific information from your network administrator.

 **NOTE:** 802.11 a/b/g/n radio module is off by default.

 **NOTE:** Suspending the terminal powers off the 802.11 a/b/g/n radio and drops the radio connection. When the terminal resumes, depending on the radio power mode and security protocol selected, it may take up to 30 seconds for the 802.11 a/b/g/n radio drivers to re-associate the radio to the network.



 **NOTE:** Area coverage and radio performance may vary, due to environmental conditions, access points types or interference caused by other devices (microwave ovens, radio transmitters, etc.).

Turning the Wi-Fi Networking On/Off

1. Touch **All Apps**  > **Settings** 
2. Touch the **Wi-Fi** OFF/ON toggle box to turn the radio  or .



Connecting to a Wi-Fi Network

1. Touch **All Apps**  > **Settings**  > **Wi-Fi**.
2. Turn Wi-Fi  **ON**.
3. The terminal searches for available Wi-Fi access points within range of the device. If the XM5 was previously connected to a Wi-Fi network, it automatically reconnects to the same network.

NOTE: To remove a Wi-Fi network the terminal was previously connected to, touch the network name, and then touch **Forget network**, to delete the stored network information.



4. Touch the network name you want to connect to from the available network list.
5. If the network is secured, a dialog box appears requesting information relevant to the network security protocol (e.g., password, key, or certificate). Enter the required information.
6. Touch **Connect**.

Receiving Network Notifications

If Wi-Fi networking is turned On, you can set the terminal to notify you when an open network is available.

1. Touch **All Apps**  > **Settings**  > **Wi-Fi**.
2. Press the **Menu** button  on the bottom right, and then touch **Advanced**.
3. Touch the check box to toggle **Network notification** On (checked) or Off.

Adding a Wi-Fi Network

1. Touch **All Apps**  > **Settings**  > **Wi-Fi**.
2. Verify the **Wi-Fi** is turned  **ON**.
3. Touch the **+** located at the bottom of the available Wi-Fi network list.
4. Enter the **Network SSID** (Wi-Fi network name).
5. For secure Wi-Fi network connections, touch **None** under **Security**, and then select the type of security protocol required from the pop-up menu (e.g., **WEP**,

WPA/WPA2 PSK or **802.1xEAP**).

6. Enter any additional security information required by the type of security protocol selected.
7. Touch **Save**.



10.5. Advanced Wi-Fi Settings and Network Utilities

Advanced Wi-Fi Menu

The Advanced Wi-Fi menu provides access to set network notifications, modify Wi-Fi radio activity during Suspend mode, or view the terminal MAC address and IP address.

- *Network notification*
Turn on or off available Wi-Fi network notification.
- *Keep Wi-Fi on during sleep*
Set how the Wi-Fi radio reacts when the terminal enters sleep (Suspend) mode (i.e., Always, Only when plugged in, or Never).
- *Avoid poor connections*
Don't use a Wi-Fi network unless it has a good Internet connection
- *Wi-Fi optimization*
Minimize battery usage when Wi-Fi is on
- *MAC address*
- *IP address*

To access the advanced Wi-Fi menu settings:





1. Touch **All Apps**  > **Settings** .
2. Under **Wireless & Networks**, touch **Wi-Fi**.
3. Press the **Menu** button  on the bottom right.
4. Select **Advanced**.

11. Bluetooth Handler

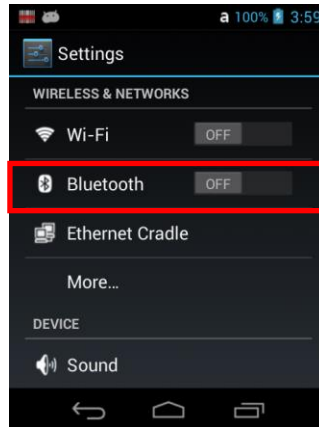

Bluetooth wireless technology is a short-range communications technology to connect portable and/or fixed devices while maintaining high levels of security.

11.1. Enabling the Bluetooth Radio



1. Tap **All Apps**  > **Settings** 
2. Tap the **Bluetooth** OFF/ON toggle box to turn the radio  or .

The Bluetooth icon  appears in the status bar.

 **NOTE:** Bluetooth is off by default. The module must be powered on using **All Apps**  > **Settings** 

 **NOTE:** Suspending the terminal powers off the Bluetooth radio and drops the Bluetooth connection. When the terminal resumes, it takes approximately 10 seconds for the Bluetooth radio driver to re-initialize the radio.

 **NOTE:** Area coverage and Bluetooth radio performance may vary, due to environmental conditions or interference caused by other devices (microwave ovens, radio transmitters, etc.).

11.2. Connecting to Other Devices

Before connecting to another device, make sure that the Bluetooth connection on the other device is enabled.

1. Tap **All Apps**  > **Settings**  > **Bluetooth**

The Bluetooth Handler appears on the screen.

2. Tap **Search for Devices** button at the bottom.

The available services of all devices/profiles in range display in the Bluetooth Handler.

11.3. Pairing Bluetooth Devices

Connecting Bluetooth devices usually requires that they be paired; the same passkey must be entered for each device. If you want to connect the MOBILE COMPUTER to a device without any input method (e.g., printers, headsets), refer to the user documentation that accompanied the device for pairing information.

1. Tap on the desired device/profile in the Bluetooth Handler.
2. Tap the Next Button on the bottom

Once asked if you need to authenticate the device,

3. Enter 4 random digits and tap the Next button.
4. Enter the same digits on the other device when prompted.
5. After pairing, tap on the selected device / profile and select Active.

11.4. ***Setting Up a Bluetooth Printer***

1. Make sure that the Bluetooth printer is on and activated.
2. If not done so already, turn Bluetooth On (by selecting the vertical arrow on the Command Bar).
3. Tap **Scan Device**, which runs a Bluetooth Inquiry, then SDP Query.
4. If you see your Bluetooth printer device displayed. You can press the Refresh button to search again.

12. Camera

12.1. Introduction

The XM Series devices feature an integrated camera for capturing still photographic pictures and video, which is useful for documentation of inventory locations, product damage or work procedure and more.

Specification:

The SAMSUNG S5K4ECGX is a highly integrated 5 megapixel camera. The image signal processor performs sophisticated image processing functions including color recovery and correction, false color suppression, lens shading correction, noise removal, edge enhancement, programmable gamma correction, image down scaling, auto defect correction, auto dark level compensation, auto flicker correction (50/60Hz), auto exposure (AE), auto white balance (AWB) and auto focus (AF).

12.2 Camera Function

To activate the Camera:

1. From the **Home** screen, touch



Apps.



2. Touch **Camera** icon.

- The touch screen will convert to the **Camera Viewfinder** immediately upon activation of the **Camera** function, returning to the last mode used.

✓ **Tip:** For fast access to the **Camera** function, the **Camera** shortcut can be copied to a **Home** screen panel.

12.3 Camera Controls Overview

- Touching the lowest part of the touch screen activates the basic Navigation controls.

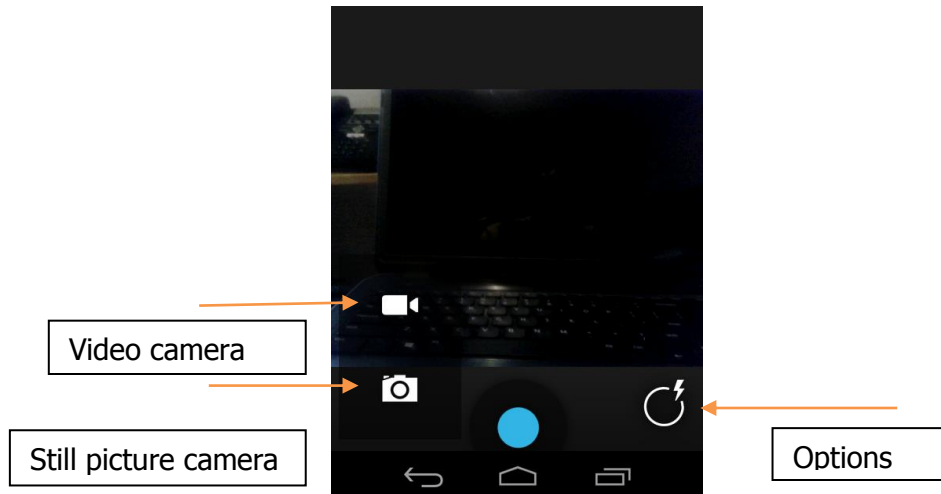

12.4 Key Camera Adjustments and Options Overview

A variety of still picture and video recording options are available.

To make key camera adjustments and set options:

- From an active camera screen, touch **Options Control** icon.
- The default camera start mode will be still picture capture.
- The Options menu will appear.

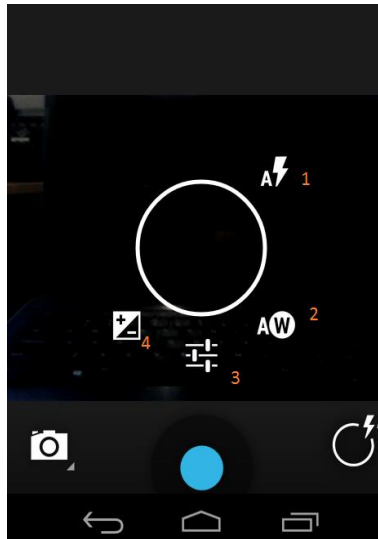

Key Camera Adjustments and Options Overview (continued)

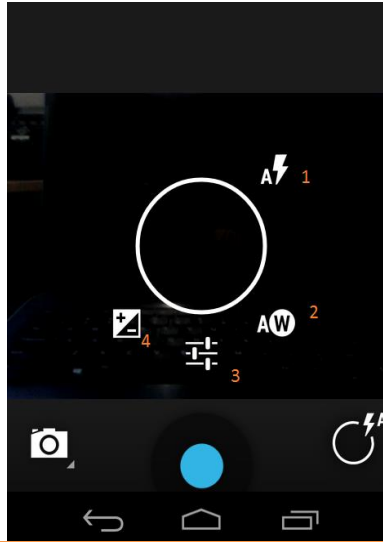

1. Flash control
 2. White balance Compensation value.
 3. Activates the Sub-settings menu (refer to Figure 5 on the following page), providing access to:
 - Scene mode(s) (refer to Figure 5 page 6-6.):
 - *Auto* (default) — Best for everyday picture taking.
 - *Night* — Compensates for low light and scenes with large dark areas.
 - *Sunset* — Compensates for the extremely bright area of setting sun against a much more dimly lit foreground.
 - *Party* — Take photos in a dim lit room; exposure and shutter speed are automatically adjusted for room brightness. Captures indoor background lighting or candlelight. Hold the camera very steady when using this mode.
 - Store location (ON or OFF)
 - Stores the location (longitude and latitude) of where the picture is taken
 - Picture size
 4. Exposure.
-
-

12.5 Camera Specifications

- Still pictures (default setting)
 - Brightness (+- 3 f-stops)
-



- Resolution (still mode)
 - 320x240, 640x480, 1280x960 1MP
 - 1600x1200 2MP
 - 2048x1536 3MP
 - 2592x1944 5MP
 - Modes
 - Normal (single shot still pictures)
 - Burst (continues shooting of still pictures)
 - Timer (delayed shutter release)
 - Video recording
 - QVGA 320x280 or
 - VGA 640x480
- Flash (Auto, On, Off)
 - Picture quality/compression
 - High
 - Normal
 - Low
 - Full Screen (viewfinder)
 - File Options
 - File name prefix
 - Save-to location

13. Phone

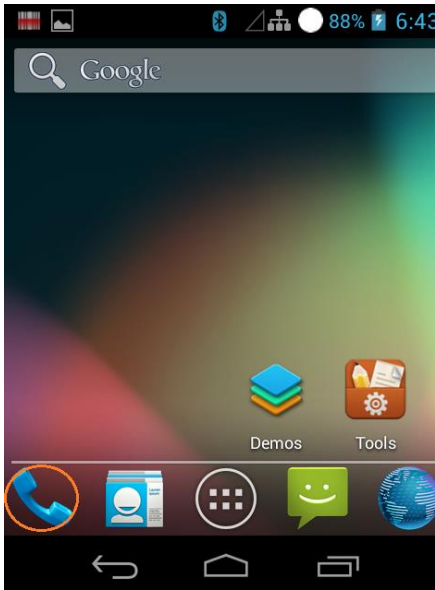
You can make calls from the Phone app, the People app, or other widgets that display contact information. Wherever you see a phone number, you can usually touch it to dial.



To open the Phone app, touch the Phone icon on a Home or All Apps screen. There are three sections in the Phone app:

-  Call log. The call log displays incoming, outgoing, and missed calls.
-  Dialer. Let's you dial manually. To make a call; type the number, then touch the Phone icon below the keypad. If you type a wrong number, touch the Backspace icon to erase digits one by one. To end a call in progress, touch the End Call icon at the bottom of the screen.
-  Menu. Touch the Menu icon to access your contacts or Call Settings.

13.1 **Status Icons** – *the icons appear at the top of the screen and display important information about the device.*

 Call in progress –

 Missed call–

 New SMS or MMS–

13.2 **Answer or Divert a Call**

When you receive a phone call, the Incoming Call screen opens and displays the phone number. If the caller is an existing contact in your Peoples app, additional information may be displayed.

When a call arrives, touch the white phone icon and slide over to one of the following icons:



Answer call Start talking to the caller.



Send to voicemail. Direct the caller to leave a voicemail message.

Send a message. Opens a list of quick text responses. Touch one to send it to the caller immediately.





Silence an incoming phone call

To silence the ringing sound, before answering the call, press the Volume down button on the side of your phone.

Call log

All incoming calls are recorded in the Phone app's call log tab. If you miss a call, you will receive a notification.

Options during a call

	Shows the keypad
	Turns the speakerphone on or off. If a Bluetooth headset is connected, this functions as a three-way switch among the built-in earpiece, the speakerphone, and the headset. The icon changes to indicate the current output. Touch & hold to see a three-way menu.
	Mute your microphone.
	Put the other party on hold.

14. Tools

Take Bug Report

This will collect information about the current device state. It creates a report and folder named

Bugreports in the root storage that can be sent to a Janam Service Center for analysis.

Program Buttons

To use the **Program Button**, tap **All Apps**  > **Tools**  > **Program Buttons**.

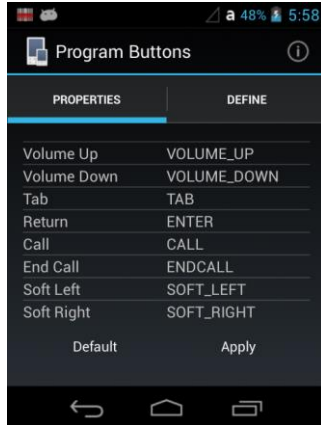

14.1 Properties

To change the setting of the button:

1. Select the button you want to change.
2. Choose its function; e.g. TabKey, Vibrator, or run an application
Default – button will be assigned default function.
3. To exit, press **OK** button.

CPU Settings

By default the CPU runs at 600MHz, which should be adequate for most applications. You have the option to change the CPU to 800 an 1000 MHz.

14.2 NoNaviBar

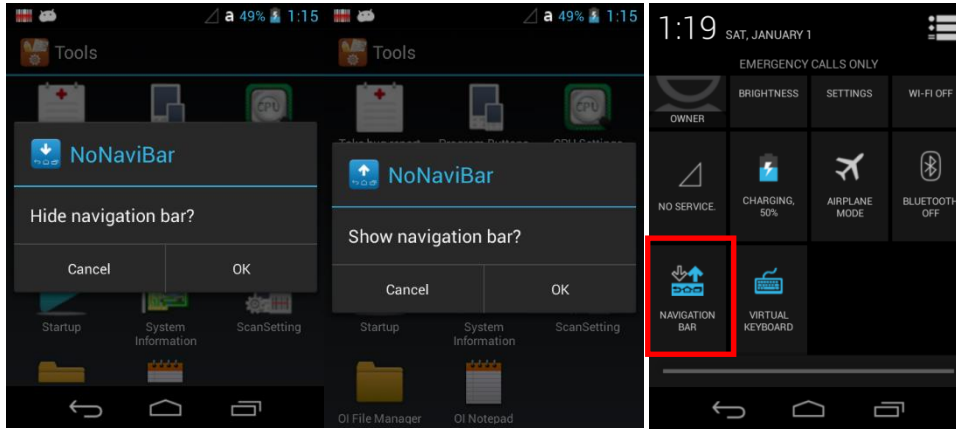

Hide / Show Navigation Bar

Tap All Apps (⋮) > Tools (⚙️) > NoNaviBar or Quick Settings Panel or you can use the Quick setting Panel

14.3 NoSIP

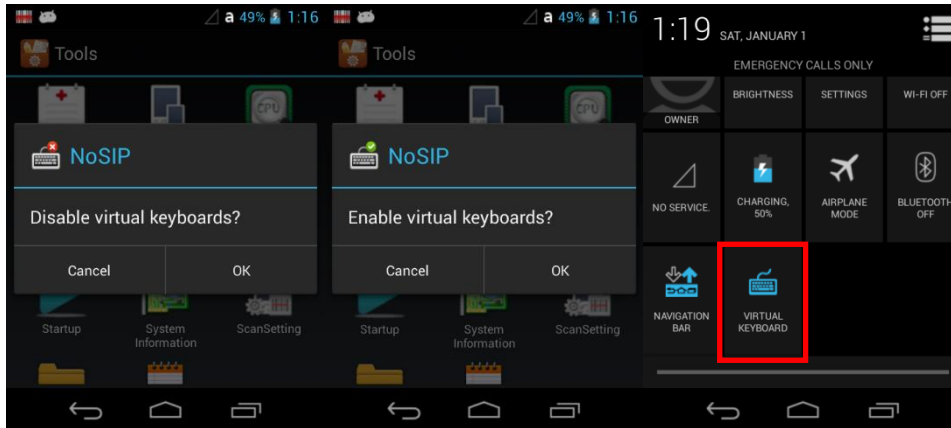

Disable / Enable virtual Keyboard

Tap All Apps (⋮) > Tools (⚙️) > NoSIP or you can use the Quick setting Panel

15. Using the XM5 Demos

15.1 Introduction

The XM5 is preloaded with these helpful demonstration and troubleshooting applications.



15.2 GPS Demo – Overview

Janam XM Series devices provide integrated GPS functionality featuring u-blox 7 receiver technology, engineered to meet the needs of mobile handheld applications. Fast satellite acquisition and excellent tracking performance combine to offer accurate navigation information.

In order to acquire the GPS data, third party navigation software is required. For Demo purposes, the XM Series device has an application in the Demos Folder, called GPS Demo. It may take a few minutes to acquire satellite signals and the best results will be obtained when the XM Series device is positioned outside with a clear and unobstructed view of the sky. When indoors or without a clear view of the sky, the acquisition time to get a fixed position will take much longer or the GPS signal may be completely unavailable. GPS performance can also be negatively affected if your vehicle has thermal glass windows, so position your XM5 where there is a clear view of the sky.

Also the power to the GPS module will turn off when the XM Series device suspends, so after resuming there could be a delay in receiving the GPS data depending on where the unit is located upon resuming.

15.3 Image Demo – Overview

The Imaging Demo demonstrates the imaging functionality of the on-board image engine, such as picture formatting, saving and printing.

To Capture Images

1. Tap Home > Demos > Image Demo. The Imaging Demo opens.

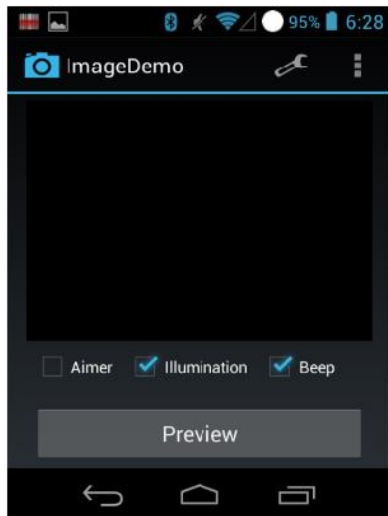

The screen is blank until you press any of the three scan buttons.

2. Press any SCAN key to activate the image engine. A preview of the image appears on the screen. The previewed image has a degraded appearance. This is normal. The previewed image is not the same as the captured image; the captured image will not have the same degradation.
3. Release the button or trigger. The captured image appears on the screen.

Saved Images

Images are saved in the Pictures folder. Use OI File Manager to access the images.

15.4 NFC Demo – Overview

Near Field Communication (NFC) is a set of ideas and technology that enables smartphones and other devices to establish radio communication with each other by touching them together or bringing them into proximity, typically a distance of 10 cm (3.9 in) or less. It operates within the globally available and unlicensed radio frequency ISM band of 13.56 MHz on ISO/IEC 18000-3 air interface and at rates ranging from 106 kbit/s to 424 kbit/s. 2006). The NFC Forum defines four types of tags that provide different communication speeds and capabilities in terms of flexibility, memory, security, data retention and write endurance. The Forum also promotes NFC and certifies device compliance^[3] and if it fits the criteria for being considered a personal area network.

Using the NFC Demo

The NFC Demo demonstrates the basic NFC capabilities of the terminal and is not intended as a functional business solution.

NFC Tag Reading

1. Start the NFC Tag Demo from "Home", "Demos".
2. To read information from a passive tagged item hold the NFC tag close to the scanner window at the top of the XM5
3. Tap the "Nfc Start" button to read and populate the application data fields.
- 4.

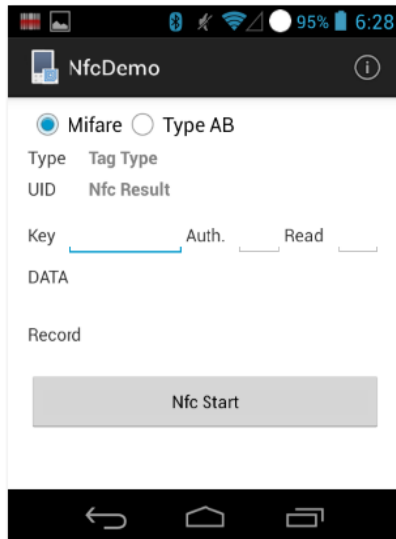

15.5 Ping Demo – Overview

The Ping Demo is a basic Internet program that allows a user to verify that a particular IP address exists and can accept requests.

To setup the Ping Demo

Tap "Home" > Demos > Ping Demo. The Ping Tool opens. Ensure you have a WiFi connection for this test. See Wireless Configuration (chapter 10). The Ping tool is default to send requests to www.google.com.

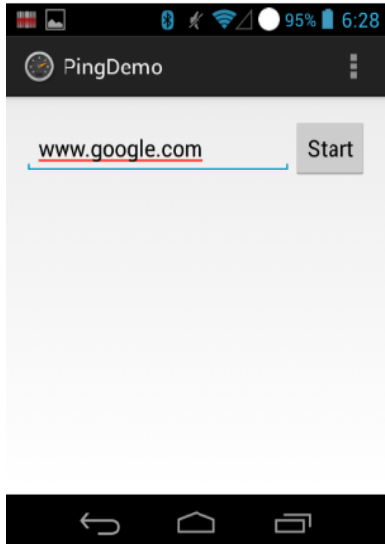

15.6 Print Demo – Overview

The Print Demo test-prints a sample bar code or receipt to compatible Bluetooth printers. The bar code and receipt files that print are formatted for their respective printer hardware.

15.7 Scan Demo – Overview

Upon successful decode provides the barcode type and scanned result.

Allows setting of trigger mode, Auto/Continuous. Decode Mode: Standard, the scan engine looks for any bar code within range.

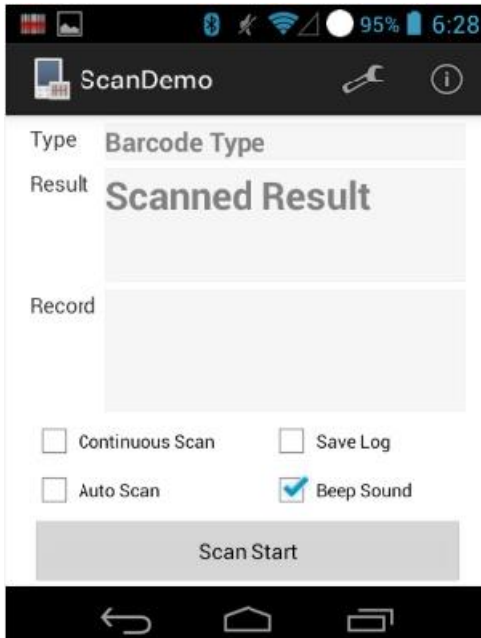

16. Single Slot cradle/Single Ethernet cradle Device

 **NOTE:** The cradle is option accessory and needed to purchase separately with incidental expenses in the aftermarket

16.1 Overview

 **NOTE:** The information in this chapter applies to both the Single Slot cradle and Single Ethernet cradle devices unless otherwise indicated.

As the hub of your MOBILE COMPUTER system, the Single Slot cradle charging and communication cradle supports full-speed USB 2.0 with a workstation. The Single Ethernet cradle is identical to the Single Slot cradle except it supports Ethernet communication as well as full-speed USB 2.0

16.2 Battery Charging

The single slot cradle charges a battery pack in 5 hours.

In addition to charging, the base powers the terminal's intelligent battery charging system, which protects the battery from being damaged by overcharging. The terminal senses when a battery pack is fully charged and automatically turns off the charger. If the battery voltage drops below the charge threshold, the charger turns on again to maintain the battery at full capacity. As a result, Mobile computers may be stored in the base indefinitely without damage to the terminals, battery packs, or peripherals. For prolonged storage, see Storage Guidelines on paragraph 4.20.

16.3 Power Supply

 **WARNING:** We recommend use of Janam peripherals, power cables, and power adapters. Use of any non Janam peripherals, cables, or power adapters may cause damage not covered by the warranty. We recommend use of Janam Li-Ion battery packs. Use of any non-Janam battery may damage not covered by warranty.

 **WARNING:** DO NOT attempt to charge damp/wet mobile computers or batteries. All components must be dry before connecting to an external power source.

16.4 Front Panel

Terminal Well

Place the XM5 in the single slot cradle to communicate with a host device, power the terminal, and charge the terminal's battery. Make sure that the device is securely seated.

Charging LED

Red – charging, Green – charged.

16.5 Back Panel

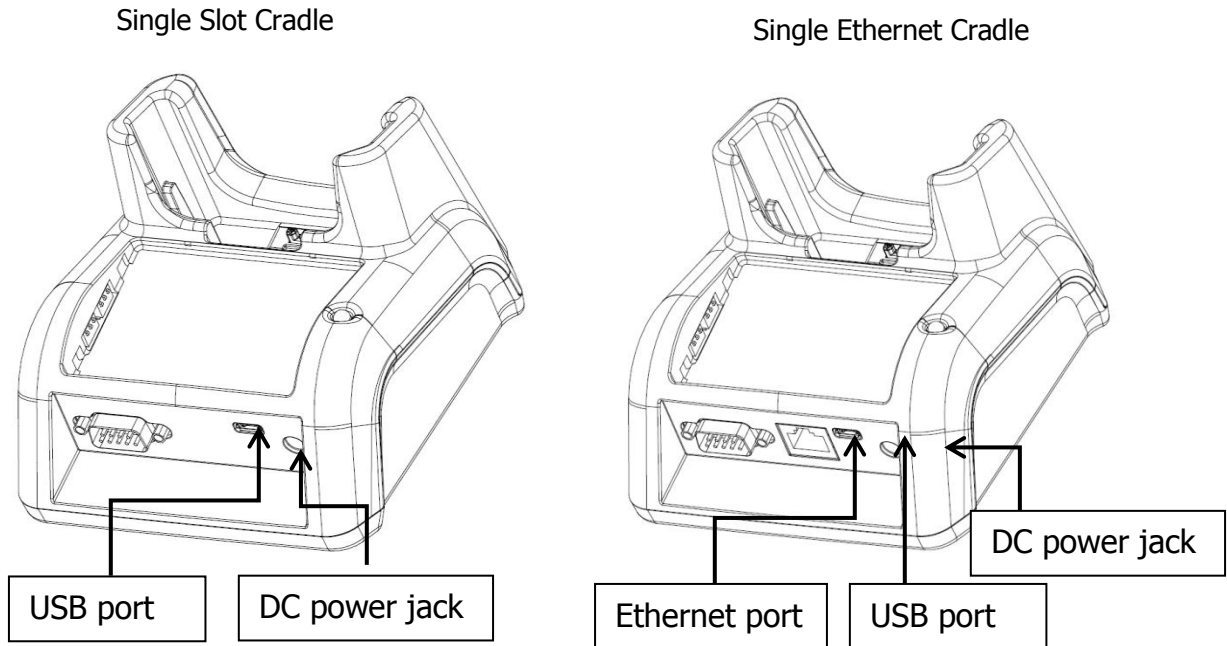

DC Power Jack

Connect the power cable to this power jack; see powering the Single Slot Cradle Device on paragraph 12.6.

USB Port

The USB port is full-speed (v2.0). Using the USB cable, you can connect the base to a USB-compliant device to facilitate USB communication to and from the terminal, see USB Communication on paragraph 10.4.

Ethernet Port (Single Ethernet cradle only)

Using an Ethernet cable, you can connect the Single Ethernet cradle to an Ethernet-compliant device to facilitate Ethernet communication to and from the terminal. This equipment is for indoor use only. The communication wiring is limited to the inside of a building.

16.6 Powering the Single Slot Cradle or Single Ethernet Cradle Device

The terminal requires DC 5V input for communication and battery charging; the power adapter on the power cable converts the voltage from the power source to DC 5V. Only power adapter cables from Janam convert the voltage appropriately.

The same power cable that ships with each terminal can be used to power the base. This cable contains a plug adapter for each geography (US, UK, EU, etc.).

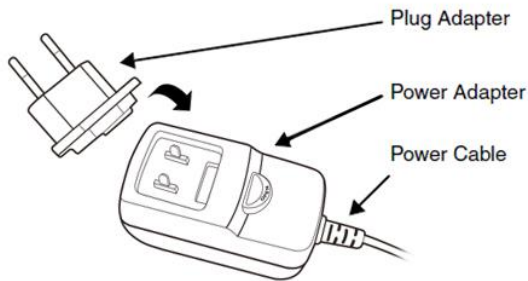

1. Attach the appropriate plug adapter to the power adapter.
2. Plug the power cable into the power source.
3. Plug the connector into the DC power jack on the back panel. The base is now powered.

When a terminal is properly seated, the base powers the terminal, charges the terminal's main battery pack, and launches MTP (see USB Communication on paragraph 10.4).

Janam recommends that you leave the base connected to its power source at all times, so that it is always ready to use.

16.7 Charging the Battery

The single slot cradle powers the terminal and fully charges the battery pack in 5 hours. The cradle has an external charge slot for charging a hot swap battery. Angle the battery as shown. Once the connectors engage, the LED lights red for charging and green if charged.



WARNING: Do not short-circuit between each contact of the cradle. It may cause fire.

AVERTISSEMENT: Provoquer un court-circuit entre les contacts de la station d'accueil, pourrait provoquer un incendie.

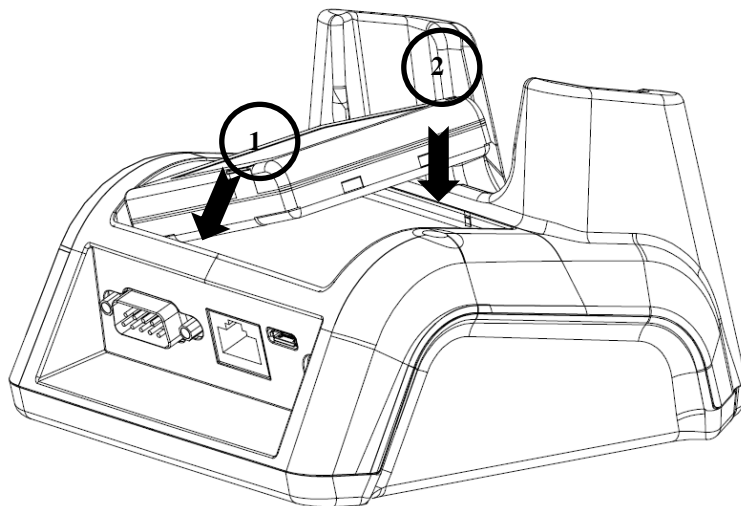

16.8 Technical Specifications for Cradle

Model	CRD-P1-005U (XM5-Single Slot Cradle) CRD -P1-005E (XM5-Single Ethernet Cradle)
Structural	
Dimensions	135.5mm(L) x 116mm(W) x 81mm(H)
Weight	Single Slot cradle - 320g Single Ethernet cradle - 325g
Material	Polycarbonate
Color	Black
Environmental	
Operating Temperature	-20° to 55°C
Storage Temperature	-25° to +70°C
Charging Temperature	0~45°C (±3°C)
Electrical Static Discharge	Air: ± 15Kv Direct: ± 8 kV
Humidity	95% humidity (non-condensing)
Power Supply	
Input (Universal) (from the power source)	AC 100–240 Vac. 50/60Hz 0.9A Included with Cradle
Output (to the cradle)	DC 5V , 4A
Charging	
Standard Charge	Main battery: Standard Capacity:4000mAh (60-BTSC) – Approx. 5hours
Status LED	Green: charged Red: charging
Communication	

Interface	MicroUSB connector supports data transmission of up to 480Mbps OR Ethernet 10/100BASE-T(support only CRD -P1-005E)
Agency Approvals	
Power Supply	UL listed TUV licensed Power Supply compliant to FCC part 15, Class B
Charging	CE Marking (EMC) CISPR Pub 22
Fire Retardant	UL 94- HB

17. 4-Slot Battery Charger

 **NOTE:** The 4-Slot Battery Charger is option accessory and needed to purchase separately with incidental expenses in the aftermarket

17.1 Overview

The 4-Slot Battery Charger device is a four-slot charging station that charges up to four Li-ion battery Packs (**standard capacity 4000mAh : 60-BTSC**) in five hours.

17.2 Power Supply

The power cable that ships with each charger



WARNING: We recommend use of Janam peripherals, power cables, and power adapters. Use of any non-Janam peripherals, cables, or power adapters may cause damage not covered by the warranty. We recommend use of Janam Li-Ion battery packs. Use of any non-Janam battery may cause damage not covered by warranty.



WARNING: DO NOT attempt to charge damp/wet mobile computers or batteries. All components must be dry before connecting to an external power source.

17.3 Front Panel

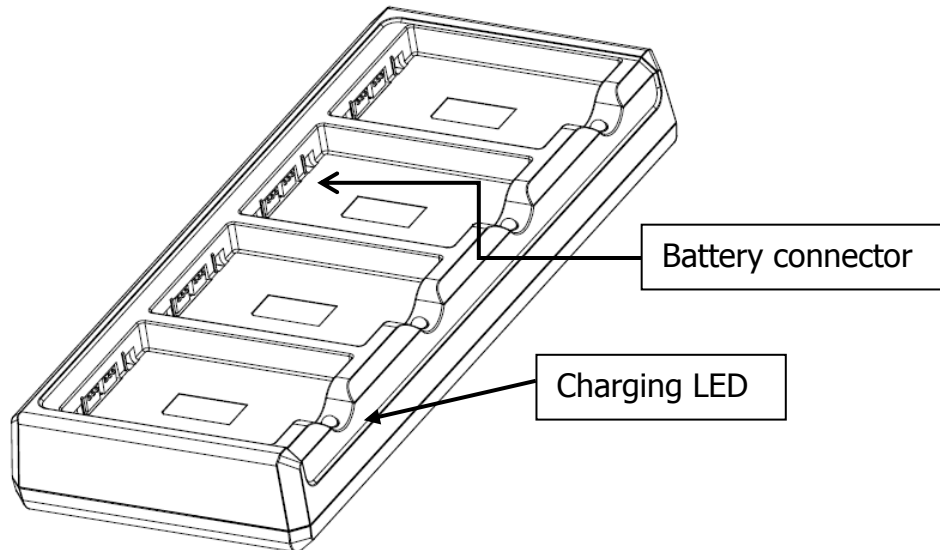

Charging Slots

The charger contains four charging slots. Each slot holds one battery. When a battery is placed in a slot, it immediately begins charging and its Status LED lights.

Charging LED

If the LED is red, the unit is charging; if it is green, the charge is complete.

17.4 Back Panel

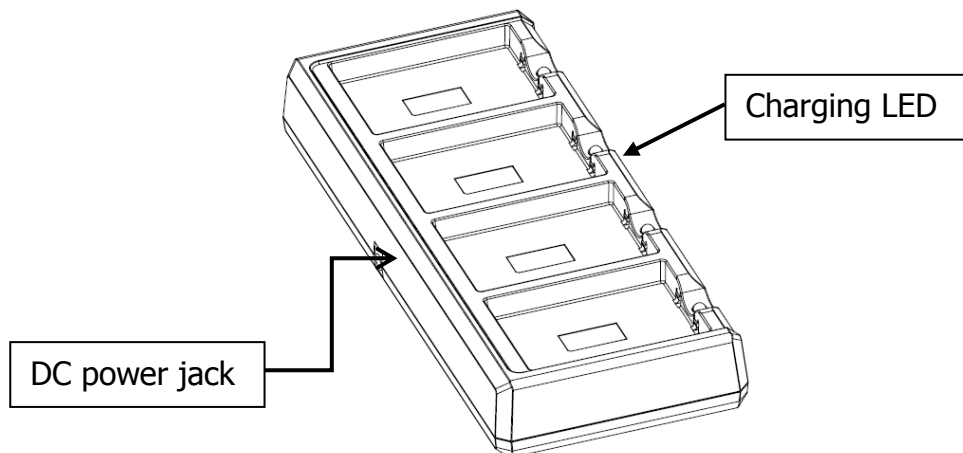

DC Power Jack

Connect the power cable to this power jack; see powering the Single Slot Cradle Device on paragraph 12.6

17.5 Charging the Battery

The base powers the terminal and fully charges the battery pack in 5 hours depending on the battery.

Angle the battery as shown. Once the connectors engage, the LED lights. If the LED is red, the unit is charging; if it is green, the charge is complete

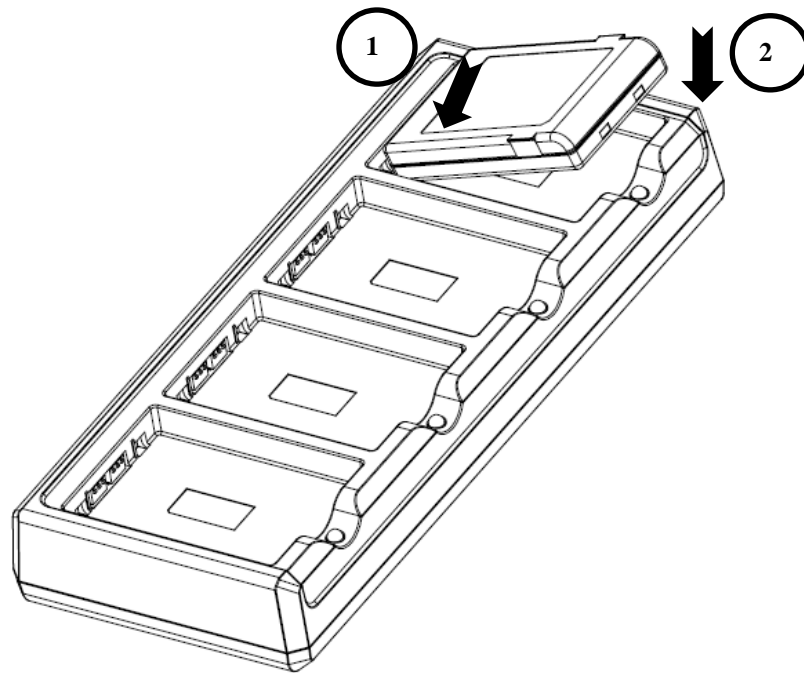

17.6 Technical Specifications for 4slot battery charger

Model	BC-P4-005 (XM5-4Slot Battery Charger)
Structural	
Dimensions	256mm(L) x 105mm(W) x 37mm(H)
Weight	4- Slot Battery Charger - 434g
Material	Polycarbonate
Color	Black
Environmental	
Operating Temperature	-20° to 55°C
Storage Temperature	-25° to +70°C
Charging Temperature	0~45°C (±3°C)
Electrical Static Discharge	Air: ± 15kV Direct: ± 8 kV
Humidity	95% humidity (non-condensing)
Power Supply	
Input (Universal) (from the power source)	AC 100–240 Vac. 50/60Hz 0.9A Included with Charger
Output (to the cradle)	DC 5V , 4A
Charging	
Standard Charge	Main battery: Standard Capacity:4000mAh (60-BTSC) – Approx. 5hours
Status LED	Green: charged Red: charging
Agency Approvals	
Power Supply	UL listed TUV licensed Power Supply compliant to FCC part 15, Class B
Charging	CE Marking (EMC) CISPR Pub 22
Fire Retardant	UL 94- HB